

PA10 SERIES

Multi high function, Sensor controller

■ Features

- 12 kinds of various operation modes selected by DIP S/W
- High speed input response
- Flip-flop function built in for lever control
- Multi function type with Timer function
- DIN rail mounting
- Wide range of power supply (100–240VAC 50/60Hz)

⚠ Please read "Caution for your safety" in operation manual before using.



■ Ordering information

PA	10	—	U	
			P	NPN input
			P	PNP input
			U	High function controller
			V	Controller
			W	2 channel controller
			10	Multi-function
			PA	Power Amplifier

■ Specifications

Model	PA10-U	PA10-V	PA10-VP	PA10-W	PA10-WP
Power supply	100–240VAC 50/60Hz				
Allowable operation voltage	90~110% of rate voltage				
Power consumption	100VAC 50/60Hz : Approx. 7VA (Condoton:12VDC/200mA resistive load), 240VAC 50/60Hz : Approx. 10VA				
Power for external sensor	12VDC ±10% max. 200mA				
Input(IN1)(IN2)	Selectable NORM/INV. Selectable OR/AND operation for IN1, IN2 input. Selection function for IN2 derivative action.	Selectable NORM/INV. Operation for IN1, IN2 AND.		Selectable NORM/INV. Selection function for IN1, IN2 individual operation.	
	NPN input type	NPN input type	PNP input type	NPN input type	PNP input type
Input type	●PA10-U [No-voltage input] Impedance at short-circuit:Max. 680Ω, Residual voltage at short-circuit:Max. 0.8V, Impedance at open:Min. 100kΩ ●PA10-V/PA10-W [No-voltage input] Impedance at short-circuit:Max. 300Ω, Residual voltage at short-circuit:Max. 2V, Impedance at open:Min. 100kΩ ●PA10-VP/PA10-WP [Voltage input] Input impedance:5.6kΩ, "H" level voltage:5–30VDC, "L" level voltage:0–2VDC				
Output	Contact output	OUT : 250VAC 3A(resistive load)		OUT1, OUT2 : 250VAC 3A(resistive load)	
	Solid-state output	O·C OUT1/O·C OUT2 : NPN open collector output Max. 30VDC 200mA	O·C OUT : NPN open collector output max. 30VDC 200mA		—————
Response time	Relay contact : Approx. 10ms, Transistor output : Max. 0.5μs (When it is encoder mode)				
Timer function	<ul style="list-style-type: none"> • ON-Delay • OFF-Delay • Flicker • Flicker One-shot • High-Speed Detection • Low-Speed Detection • One-Shot Delay Selectable(0.01~0.1/0.1~1/1~10/10~100 sec)	Have	—————		
	<ul style="list-style-type: none"> • NORMAL • FLIP-FLOP • ENCODER(Mode 9~11)□ 	None	—————		
Relay life cycle	Mechanical	Min. 10,000,000 times			
	Electrical	Min.100,000 times(250VAC 3A resistive load)			
Dielectric strength	2000VAC 50/60Hz for 1 minute				
Insulation resistance	Min. 100MΩ (at 500VDC)				
Ambient temperature	-10 ~ 55°C (at non-freezing status)				
Storage temperature	-25 ~ 60°C (at non-freezing status)□				
Ambient humidity	35 ~ 85%RH				
Weight	Approx. 150g			Approx. 160g	

※If the load is connected over 200mA at the sensor output, it may cause mechanical trouble.

SENSOR CONTROLLER

Dimensions

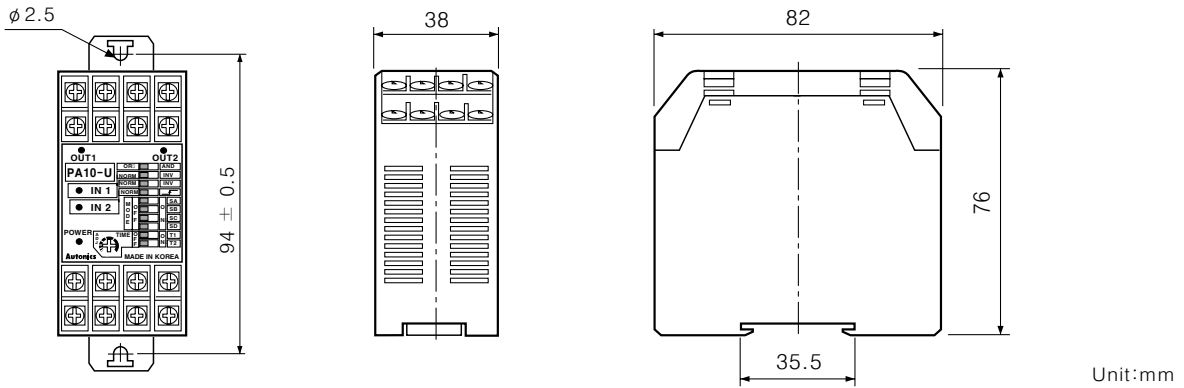

Connections

●PA10-U

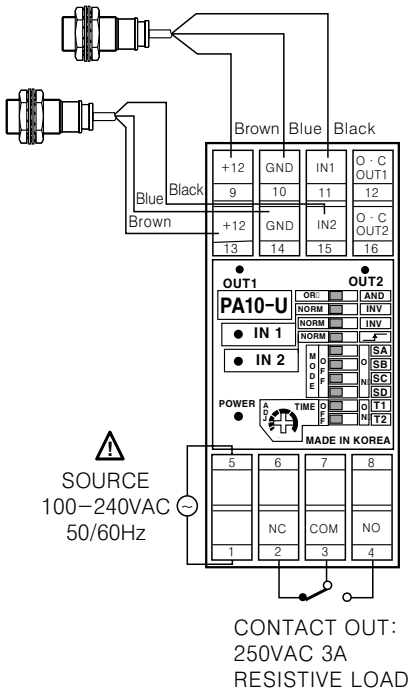

●PA10-V/PA10-VP

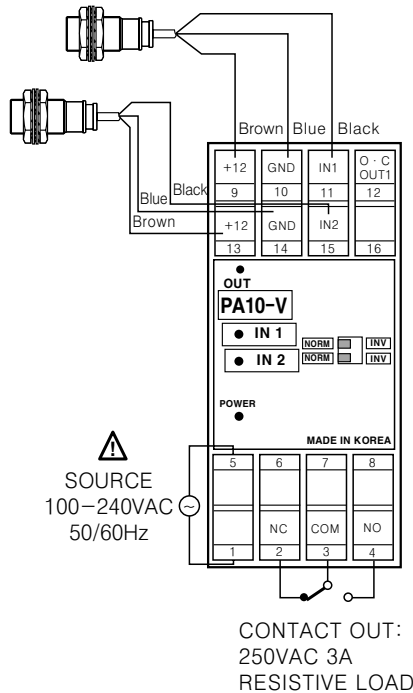

●PA10-W/PA10-WP

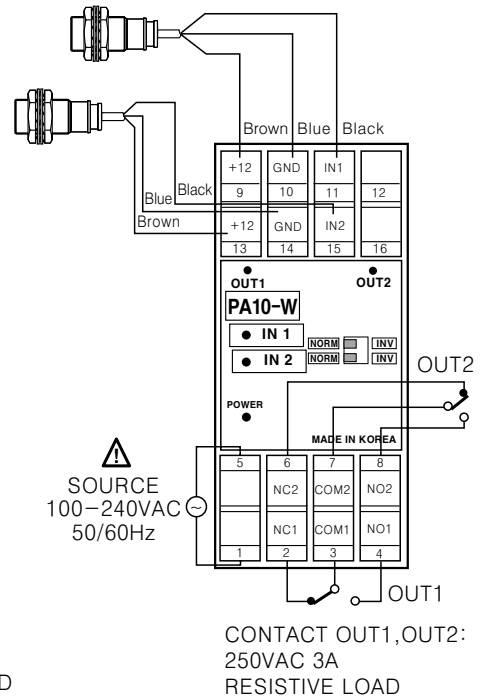

Input connctions

●PA10-U / PA10-V / PA10-W

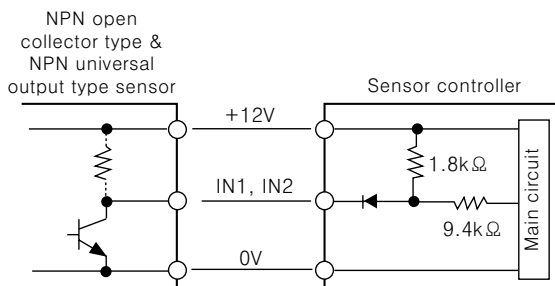

●PA10-VP / PA10-WP

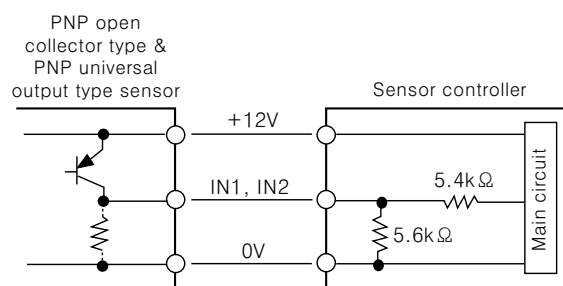

(A)
Counter

(B)
Timer

(C)
Temp.
controller

(D)
Power
controller

(E)
Panel
meter

(F)
Tacho/
Speed/
Pulse
meter

(G)
Display
unit

(H)
Sensor
controller

(I)
Proximity
sensor

(J)
Photo
electric
sensor

(K)
Pressure
sensor

(L)
Rotary
encoder

(M)
5-Phase
stepping
motor &
Driver &
Controller

PA10 SERIES

Function diagram

PA10-U

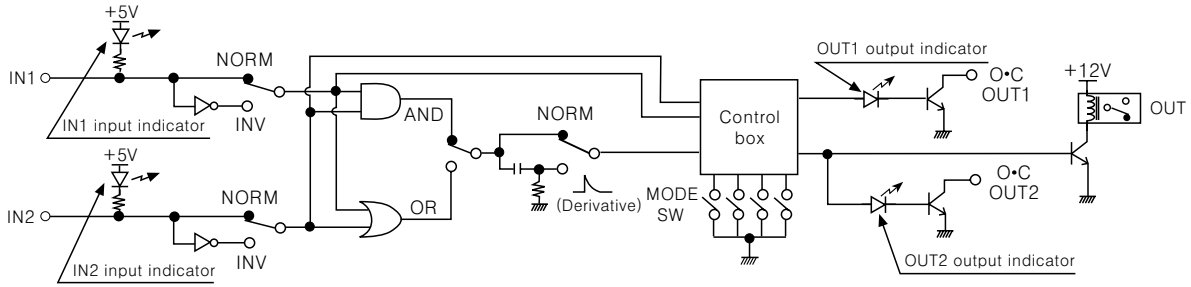

PA10-V PA10-VP

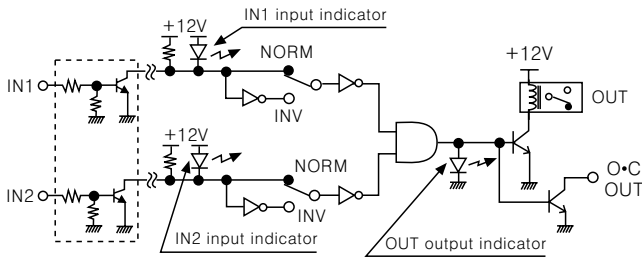

*Add when it is PNP input

PA10-W PA10-WP

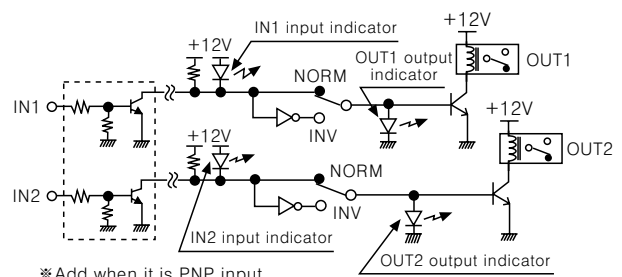

*Add when it is PNP input

Front panel identification

PA10-U

- 1 **Power indicator** : LED turns on when AC power applied
- 2 **Output indicator 1** : Indication of output signal
- 3 **Output indicator 2** : Indication of output signal
- 4 **Sensor input indicator** : Indication of sensor input signal (LED turns on when sensor input is Low)
- 5 **AND/OR selection switch** : Select "AND" or "OR" for IN1, IN2 Input
- 6 **Selection switch of sensor input signal** :

NORM	INV
------	-----

 (Input signal reverse turn function)
 - NORM : LED turns on when input signal is low. ($\overline{\square}$)
 - INV : LED turns on when input signal is high. (\square)
- 7 **Derivative action selection of IN2 input signal (OR/AND selection switch : AND)**:

NORM	Derivative
------	------------

 (When input signal is high (\square), it is effective signal)
 - NORM : IN2 input signal is operating as reverse turn function
 - Derivative : Derivative action of IN2 input signal. *See < Applications >

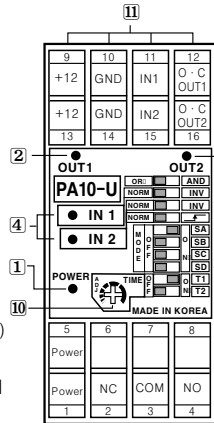

- 8 **Selection switch for operation mode** : See < Operation mode > in next page.
- 9 **Selection switch of time range and max. input frequency** : It is the switch to select time range (1~7 mode) or allowable input frequency(9~11 mode).

0	T1
F	T2

 - Time range : Approx. 0.01 ~ 0.1sec. Max. input frequency : 100kHz
 - Time range : Approx. 0.1 ~ 1sec. Max. input frequency : 10kHz
 - Time range : Approx. 0.1 ~ 10sec. Max. input frequency : 1kHz
 - Time range : Approx. 10 ~ 100sec. Max. input frequency : 100Hz
- 10 **Timer volume** : Adjust time as same as the range of No. 9 function.
- 11 **Terminal block**

PA10-V/PA10-VP

- 1 **Power indicator** : LED turns on when AC power applied
- 2 **Output indicator** : Indication of output signal
- 3 **Sensor input indicator** :
 - PA10-V : Indication of sensor input signal(LED turns on when sensor input is Low)
 - PA10-VP : Indication of sensor input signal(LED turns on when sensor input is High)
- 4 **Selection switch of sensor input signal**
 - NORM : LED turns on when input signal is low.
 - INV : LED turns on when input signal is high.
- 5 **Terminal block**
 *When IN1, IN2 input signal is AND, OUT will work.

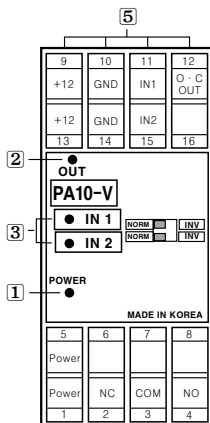

PA10-W/PA10-WP

- 1 **Power indicator** : LED turns on when AC power applied
- 2 **Output indicator** : Indication of output signal
- 3 **Sensor input indicator** :
 - PA10-W : Indication of sensor input signal(LED turns on when sensor input is Low)
 - PA10-WP : Indication of sensor input signal(LED turns on when sensor input is High)
- 4 **Selection switch of sensor input signal**
 - NORM : LED turns on when input signal is low.
 - INV : LED turns on when input signal is high.
- 5 **Terminal block**
 *Selectable NORM/INV. Selection function for IN1, IN2 individual operation.

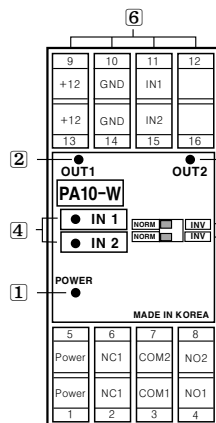

SENSOR CONTROLLER

■ Operation mode(PA10-U)

● MODE 0 NORMAL MODE

:OUT will work according to input signal regardless Timer.

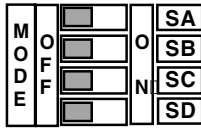

<OR function>

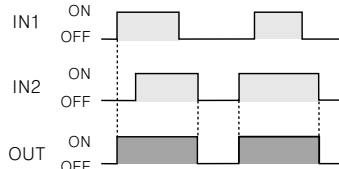

※Output will be ON when either IN1 or IN2 is ON.

<AND function>

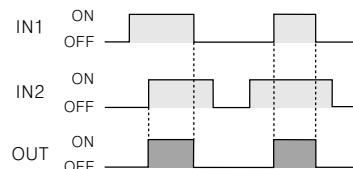

※Output will be ON when both IN1 and IN2 are ON.

● MODE 1 ON-DELAY MODE

:OUT will be ON after setting time according to one of IN1 and IN2 is ON. When IN1 and IN2 are OFF, OUT will be OFF. (This is when input logic is OR)

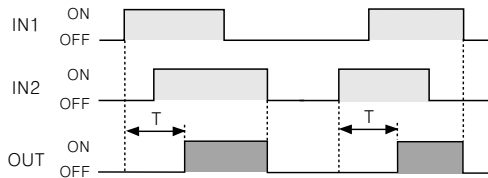
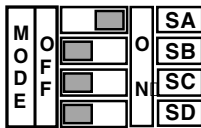

T : Setting time

● MODE 2 OFF-DELAY MODE

: OUT will be ON at the same time when IN1 or IN2 is ON then OUT will be OFF after setting time according to IN1 or IN2 is OFF. (This is when input logic is OR)

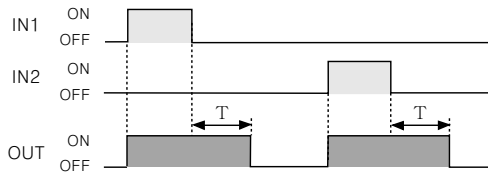
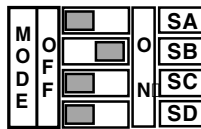

T : Setting time

● MODE 3 ONE-SHOT DELAY MODE

:OUT will be ON at the same time with IN1 or IN2 is ON then OUT will be OFF after setting time. (This is when input logic is OR)

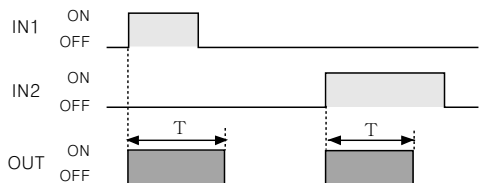
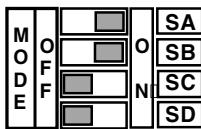

T : Setting time

● MODE 4, 5 FLICKER MODE / FLICKER ONE-SHOT MODE

:OUT will be ON after setting time for IN1 input then it is flickering and OUT will be flickering after setting time from ON. But, in case of One-shot Mode, output time(Ts) will be selected by NORM S/W.

(: Ts = Approx. 10ms, NORM : Ts = Approx. 100ms)

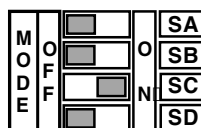

(MODE 4)

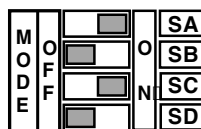

(MODE 5)

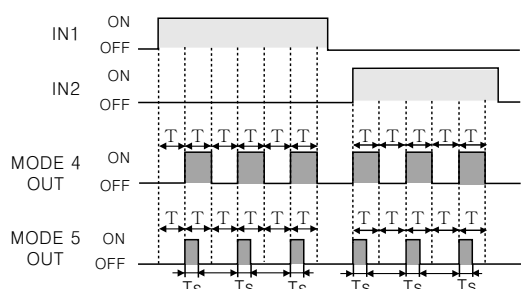

※ T : Setting time, Ts : One-Shot output time

Note)ON/OFF rate of Flicker output is 1:1.

Note)In case of Flicker Mode, it is not different between OR AND and NORM S/W.

Note)In case of One-Shot Mode, it is not different between OR AND S/W.

(A) Counter

(B) Timer

(C) Temp. controller

(D) Power controller

(E) Panel meter

(F) Tacho/ Speed/ Pulse meter

(G) Display unit

(H) Sensor controller

(I) Proximity sensor

(J) Photo electric sensor

(K) Pressure sensor

(L) Rotary encoder

(M) 5-Phase stepping motor & Driver & Controller

PA10 SERIES

■ Operation mode(PA10-U)

● MODE 6 LOW-SPEED DETECTION MODE

:OUT will be ON when input signal (IN1) is longer than setting time by comparing it to the setting time by one cycle.

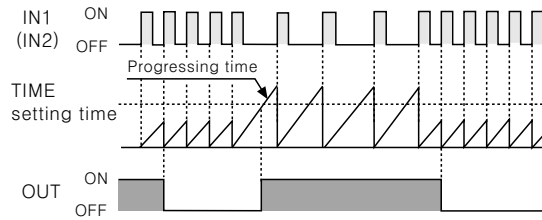
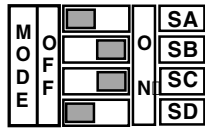

Note) Above is when input logic is OR and it will be the same by using IN2 input signal terminal instead of IN1.

Note) When use MODE 6 as above, be sure that OUT will be work at the same time with power supply.

● MODE 7 HIGH-SPEED DETECTION MODE

:OUT will be ON when input signal (IN1) is shorter than setting time by comparing it to the setting time by one cycle.

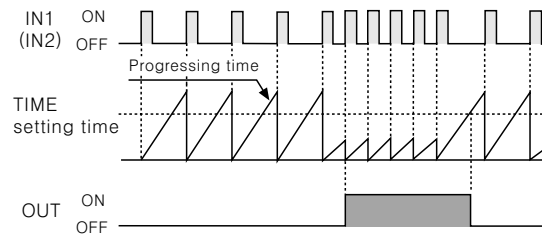
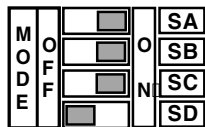

Note) Above is when input logic is OR and it will be the same by using IN2 input signal terminal instead of IN1.

◎ TIME S/W function (MODE 1 ~ MODE 7)

:Set the setting time by TIME S/W (T1, T2) and front TIME VOLUME (ADJ).

Mode Item	MODE 1 ~ MODE 7	MODE 6 ~ MODE 7
	Setting time range	Input frequency (*rpm)
	0.01 ~ 0.1sec	100 ~ 10Hz (6,000 ~ 600rpm)
	0.1 ~ 1sec	10 ~ 1Hz (600 ~ 60rpm)
	1 ~ 10sec	1 ~ 0.1Hz (60 ~ 6rpm)
	10 ~ 100sec	0.1 ~ 0.01Hz (6 ~ 0.6rpm)

*Range of operating rpm is 1 pulse per 1 revolution

*When the pulse is increasing per 1 revolution, range of operating rpm is decreasing.

● MODE 8 Flip-Flop MODE [OUT LATCH operation]

:When IN1 signal is input then the Flip-Flop output will be ON(SET). When the IN2 signal is input, Flip-Flop Signal will be OFF(RESET).

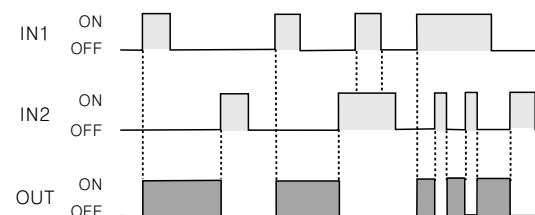
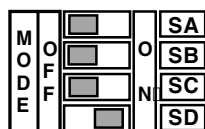

Note) IN2 will be the first of input signal.

Note) It is not different between AND and S/W.

Note) There is no Timer function in Flip-Flop Mode, therefore use this unit with Time S/W (T1, T2) are OFF.

SENSOR CONTROLLER

■ Operation mode(PA10-U)

◎ ENCODER MODE(MODE 9 ~ MODE 11)

- 1) There should be 90° phase difference between IN1 and IN2 for input terminal.
- 2) Please connect A phase output of encoder to IN1 and B phase output of encoder to IN2, when use NPN open collector or Totempole output type of encoder with PA10-U.
In this case, turned to CW direction detection signal(O.C OUT2, OUT) output of PA10-U will be OFF.
- 3) There are output function of pulse(O.C OUT1) has been multiplied(×1, ×2, ×4 times) against input signal and Direction detection output(O.C OUT2, OUT) function which detects direction of encoder rotation in Encoder mode.
- 4) Be sure to Input speed(cps) of connected equipment due to pulse width of O.C OUT1 is short.
- 5) OR AND NORM INV Selection S/W can be set at any position.

●MODE 9 ENCODER (Input pulse × 1time)

●MODE 10 ENCODER (Input pulse × 2time)

●MODE 11 ENCODER (Input pulse × 4time)

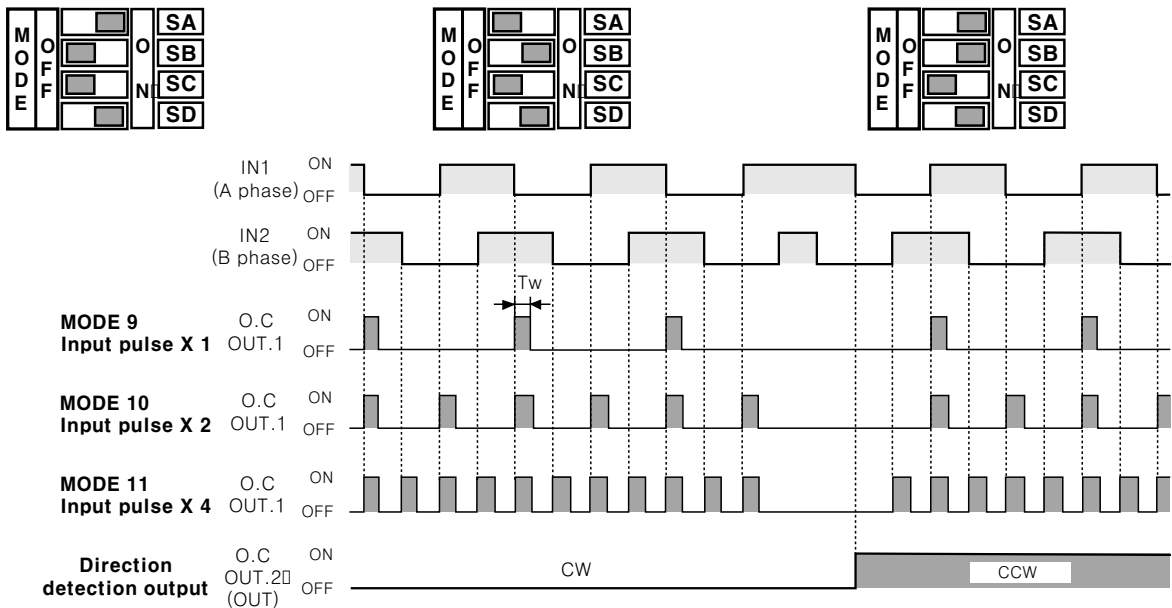

※Note)Tw(pulse width) can be changed according to max. input frequency.

◎ TIME S/W function in Encoder mode

:TIME S/W is to convert output pulse width(Tw).

TIME S/W	Max. input frequency	Output pulse width(Tw)	Input speed of connected equipment(cps)
<input type="checkbox"/> OFF <input type="checkbox"/> ON <input type="checkbox"/> T1 <input type="checkbox"/> T2	100KHz	Approx. 0.5 μ s	Min. 2000KHz(2,000kcps)
<input type="checkbox"/> OFF <input type="checkbox"/> ON <input type="checkbox"/> T1 <input type="checkbox"/> T2	10KHz	Approx. 5 μ s	Min. 200KHz(200kcps)
<input type="checkbox"/> OFF <input type="checkbox"/> ON <input type="checkbox"/> T1 <input type="checkbox"/> T2	1KHz	Approx. 50 μ s	Min. 20KHz(20kcps)
<input type="checkbox"/> OFF <input type="checkbox"/> ON <input type="checkbox"/> T1 <input type="checkbox"/> T2	100Hz	Approx. 500 μ s	Min. 2KHz(2kcps)

(A)
Counter

(B)
Timer

(C)
Temp.
controller

(D)
Power
controller

(E)
Panel
meter

(F)
Tacho/
Speed/
Pulse
meter

(G)
Display
unit

(H)
Sensor
controller

(I)
Proximity
sensor

(J)
Photo
electric
sensor

(K)
Pressure
sensor

(L)
Rotary
encoder

(M)
5-Phase
stepping
motor &
Driver &
Controller

PA10 SERIES

Derivative action applications

Detect label of glass bottle

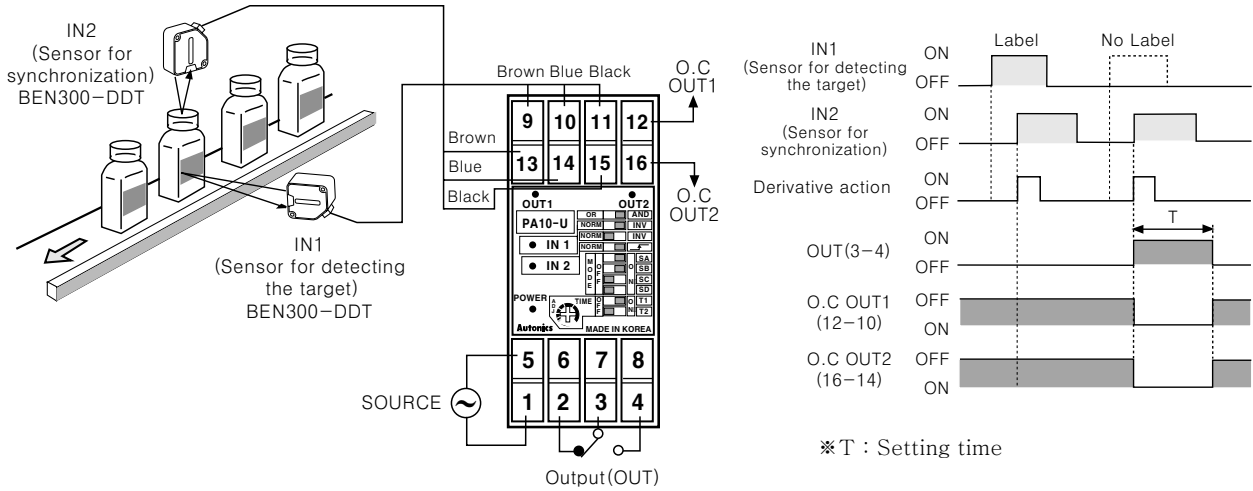

Operation

When IN1 is ON and IN2 is ON, OUT will not work.

But when there is no label on bottle, OUT will work with IN2 is ON only. OUT will be returned after setting time.

Note) Condition of detecting label on glass bottle is to install with IN1 operating first.

Proper usage

Load connections

It is important to protect from surge or noise by installing a surge absorber across inductive loads (Motor, Solenoid, etc).

In case the load is a DC relay, please install a diode across relay as shown below. (Be sure to observe proper polarity)

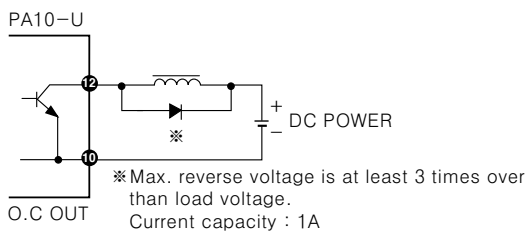
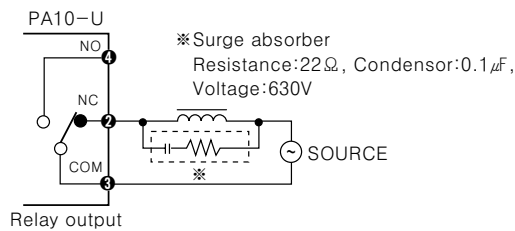

Input signal line

- Please make the cable line short from input sensor to this controller.
- Do not put input signal line with other power cable in the same conduit.
- When need to extend the input signal line, please use shielded cable.

Precaution for installation

When you need to install more than two PA10, the space between two PA10 should be larger than 10mm in order for proper cooling.

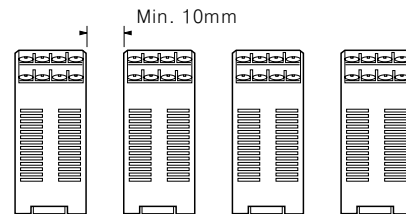

Other precautions

- Installation and dismantlement should be done with power off.
- Please check connections before wiring.
- Good ventilation must be considered to protect heating from inner components. (Ambient operating temperature is $-10^{\circ}\text{C} \sim +50^{\circ}\text{C}$)
- Do not supply over 100-240VAC.
- Do not install this controller at place where there are dust, steam, corrosive gas, water etc.
- AC power line must be separated from O.C output line or signal input line.
- This controller has been designed to have high speed response for O.C output. If use micro switch or limit switch for signal input, chattering might be occurred at O.C output.