

8 Pin Plug Digital Timer

DIN size W48×H48mm, Digital timer

■ Features

- Wide range of the time selection (0.01sec ~ 9999.9 hour)
- Power supply : 100–240VAC 50/60Hz, 12–24VDC (Option)
- Memory retention (10years)
- Micro computer built-in
- 8 PIN plug connection type

⚠ Please read "Caution for your safety" in operation manual before using.



※ Up graded since 2003. 07.

■ Ordering information

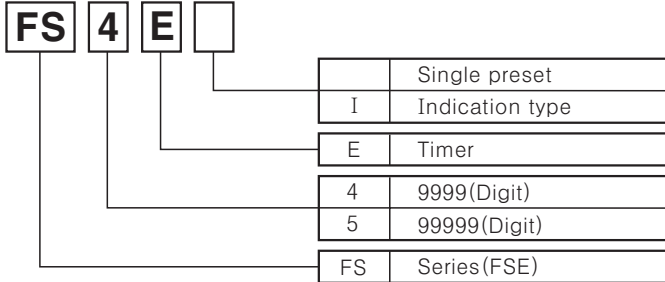

■ Specifications

※ A blacked () item is upgraded function.

Model		FS4E	FS5E1
Function		Single preset Up/Down Timer	Indication type Up/Down Timer
Character size		W4×H8mm	
Power supply		100–240VAC 50 /60Hz, 12–24VDC (Option)	
Allowable voltage range		90 ~ 110% of rated voltage	
Power consumption		Approx. 4.5VA (240VAC 60Hz), Approx. 2.5W (24VDC)	Approx. 3.5VA (240VAC 60Hz), Approx. 2.2W (24VDC)
Return time		Max. 500ms	
Min. input signal width	RESET input	Approx. 20ms	
	INHIBIT input		
Input	RESET input	• NO–voltage input – Impedance at short–circuit : Max. 470Ω, Residual voltage at short–circuit : Max. 1VDC Impedance at open circuit: Min. 100kΩ	
	INHIBIT input		
One-shot output time		(*) 0.05~5sec	
Control output	Contact type	Time–limit SPDT (1c)	—————
	Contact capacity	250VAC 3A at resistive load	—————
Relay life cycle	Mechanical	Min. 10,000,000 times	—————
	Electrical	Min. 100,000 times (250VAC 3A resistive load)	—————
Memory retention		10 years (EEPROM)	
Repeat error		Max. ±0.01% ±0.05sec	
Set error			
Voltage error			
Temperature error			
Insulation resistance		100MΩ (at 500VDC)	
Dielectric strength		2000VAC 50/60Hz for 1 minute	
Noise strength	AC power	±2kV the square wave noise (pulse width: 1μs) by the noise simulator	
	DC power	±500V the square wave noise (pulse width: 1μs) by the noise simulator	
Vibration	Mechanical	0.75mm amplitude at frequency of 10 ~ 55Hz in each of X, Y, Z directions for 1hour	
	Malfunction	0.5mm amplitude at frequency of 10 ~ 55Hz in each of X, Y, Z directions for 10 minutes	
Shock	Mechanical	300m/s ² (Approx. 30G) in X, Y, Z directions 3 times	
	Malfunction	100m/s ² (Approx. 10G) in X, Y, Z directions 3 times	
Ambient temperature		–10 ~ +55°C (at non–freezing status)	
Storage temperature		–25 ~ +65°C (at non–freezing status)	
Ambient humidity		35~85%RH	
Weight	AC power	Approx. 122g	Approx. 112g
	DC power	Approx. 130g	Approx. 120g

(A)
Counter

(B)
Timer

(C)
Temp.
controller

(D)
Power
controller

(E)
Panel
meter

(F)
Tacho/
Speed/
Pulse
meter

(G)
Display
unit

(H)
Sensor
controller

(I)
Proximity
sensor

(J)
Photo
electric
sensor

(K)
Pressure
sensor

(L)
Rotary
encoder

(M)
5-Phase
stepping
motor &
Driver &
Controller

FSE Series

Connections

FS4E

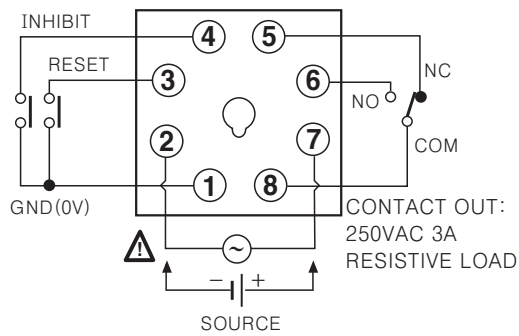

FS5EI

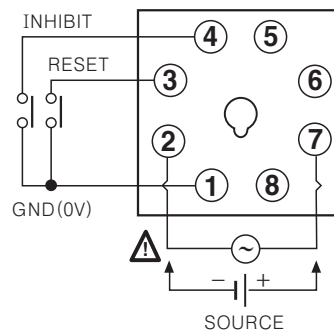

Input connections

Solid-state input

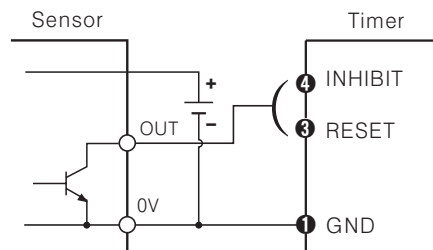

- Transistor ON → INHIBIT, RESET
 - NPN open collector output sensor
- ※ Above number are number of terminal block.

Contact input

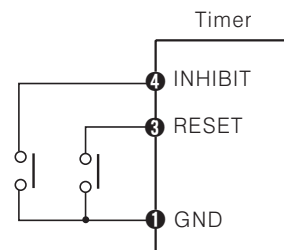

- Contact ON → INHIBIT, RESET
- Limit S/W, Micro S/W, Relay contact
- Please use a contact that can function reliable at 5VDC 1mA.

Dimensions

Bracket

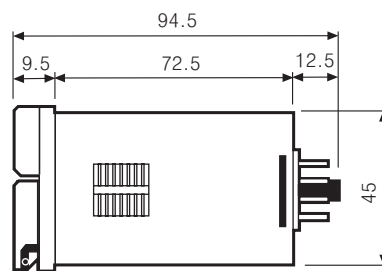
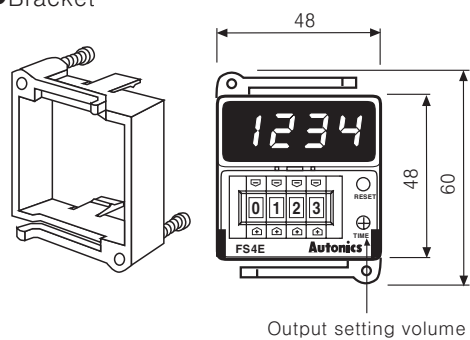

Panel cut-out

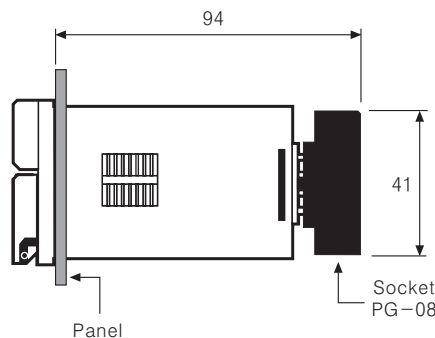
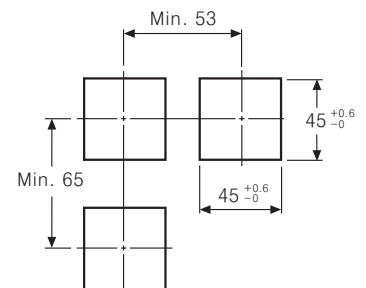

Unit:mm

8 Pin Plug Digital Timer

■ Selection by DIP switches

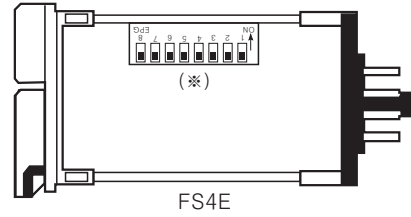
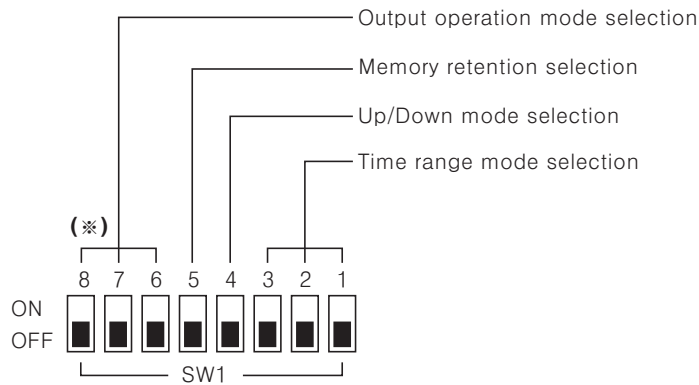

*Indication type(FS5E1) has no output mode.
(NO. 6, 7, 8 of S/W1)

※ Because number 5 of Timer and number 6 of NC are dispensable, the inner selecting switch, DIP S/W is changed from 10pin to 8pin. See former catalog for outmoded items.

● Up/Down mode

SW1	Function
ON <input type="checkbox"/>	Down mode
OFF <input checked="" type="checkbox"/>	
ON <input checked="" type="checkbox"/>	Up mode
OFF <input type="checkbox"/>	

● Memory retention

SW1	Function
ON <input type="checkbox"/>	No memory retention
OFF <input checked="" type="checkbox"/>	
ON <input checked="" type="checkbox"/>	Memory retention
OFF <input type="checkbox"/>	

■ Time range mode

SW 1	Model	FS4E	FS5E1
ON <input type="checkbox"/> <input type="checkbox"/> <input type="checkbox"/>	1 2 3	99.99sec	9999.9sec
OFF <input checked="" type="checkbox"/> <input checked="" type="checkbox"/> <input checked="" type="checkbox"/>	1 2 3	999.9sec	99999sec
ON <input type="checkbox"/> <input checked="" type="checkbox"/> <input type="checkbox"/>	1 2 3	9999sec	9min 59.99sec
OFF <input checked="" type="checkbox"/> <input type="checkbox"/> <input checked="" type="checkbox"/>	1 2 3	99min 59sec	99min 59.9sec
ON <input type="checkbox"/> <input type="checkbox"/> <input checked="" type="checkbox"/>	1 2 3	999.9min	9999.9min
OFF <input checked="" type="checkbox"/> <input checked="" type="checkbox"/> <input type="checkbox"/>	1 2 3	99hour 59min	9hour 59min 59sec
ON <input checked="" type="checkbox"/> <input checked="" type="checkbox"/> <input checked="" type="checkbox"/>	1 2 3	999.9hour	999hour 59sec
OFF <input type="checkbox"/> <input type="checkbox"/> <input type="checkbox"/>	1 2 3	9999hour	9999.9hour

(A)
Counter

(B)
Timer

(C)
Temp.
controller

(D)
Power
controller

(E)
Panel
meter

(F)
Tacho/
Speed/
Pulse
meter

(G)
Display
unit

(H)
Sensor
controller

(I)
Proximity
sensor

(J)
Photo
electric
sensor





































(K)
Pressure
sensor

(L)
Rotary
encoder

(M)
5-Phase
stepping
motor &
Driver &
Controller

FSE Series

Output operation mode (FS4E)

 ← One-shot output (0.05 ~ 5sec.)  ← Self-holding output			
Mode	 Up mode	 Down mode	Operation after time up
F	SW1 6 7 8 ON  OFF 	SW1 6 7 8 ON  OFF 	<ul style="list-style-type: none"> ●The display value continues until Reset signal applied and the output will be held.
N	SW1 6 7 8 ON  OFF 	SW1 6 7 8 ON  OFF 	<ul style="list-style-type: none"> ●The display value and output will be held until Reset signal.
C	SW1 6 7 8 ON  OFF 	SW1 6 7 8 ON  OFF 	<ul style="list-style-type: none"> ●The display returns to initial status and output will be OFF after one-shot time. ●The output is one-shot.
R	SW1 6 7 8 ON  OFF 	SW1 6 7 8 ON  OFF 	<ul style="list-style-type: none"> ●The display value will be held until output is OFF. The output will be OFF after one-shot time. ●The output is one-shot.
K	SW1 6 7 8 ON  OFF 	SW1 6 7 8 ON  OFF 	<ul style="list-style-type: none"> ●The display value continues until Reset signal applied. The output will be OFF after one-shot time. ●The output is one-shot.
P	SW1 6 7 8 ON  OFF 	SW1 6 7 8 ON  OFF 	<ul style="list-style-type: none"> ●The output and display value are held for one-shot time, but timer is reset and begins timing when set point is reached. ●The output is one-shot.
Q	SW1 6 7 8 ON  OFF 	SW1 6 7 8 ON  OFF 	<ul style="list-style-type: none"> ●The display value continues until OFF. The output will be OFF after one-shot time.
S	SW1 6 7 8 ON  OFF 	SW1 6 7 8 ON  OFF 	<ul style="list-style-type: none"> ●The output will be OFF for set time and then ON for set time and will repeat this cycle.

※ Time Up : When processing time reaches to setting time.

※ Applying reset signal after time up, it will display zero for up mode and time range for down mode (displaying max. value in case of indication type).

8 Pin Plug Digital Timer

■ Proper usage

◎Preset value

Able to change setting value while it is running but setting value should be higher than previous setting value.

◎Power

- The inner circuit voltage starts to rise up for the first 100ms after power on, the input may not work at this time. And also the inner circuit voltage drops down for the last 500ms after power off, the input may not work at this time.

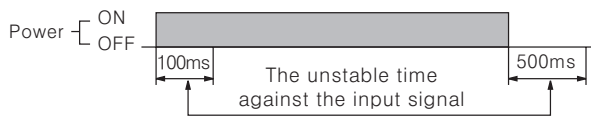

- Even though the power is applied, and the display does not turn on, please check the reset terminal.
- Please supply the power within rating power and apply or cut the power quickly to prevent chattering.

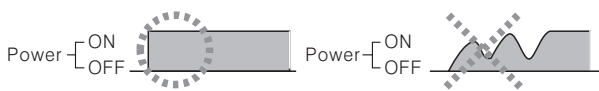

◎Input signal line

- Shorten the cable distance between the sensor and this product.
- Please use shielded wire for input signal.
- Please wire input signal line separated from power line.

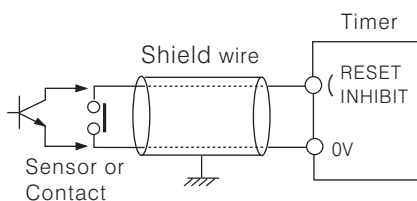

◎The reset signal width

It is reset perfectly when the reset signal is applied for max. 20ms regardless of the contact input & solid-state input.



- *In case of a contact reset, it is reset perfectly if the ON time of reset signal is applied for max. 20ms even though a chattering is occurred.

◎Error

If set value is "0000", "Error" will be displayed. If set value is changed to non-zero, this function is cancelled. However, the output in the status of Error signal will be OFF.

- ※The indicator does not have the function of indication.

◎Reset

Reset has two function, which are memorizing DATA function and resetting output function. When changing an inner selection SW, manual reset or external reset must be held after applying the power by all means. Otherwise it will operate as previous mode. Selecting a reset input/output mode again after applying power, please reset or reset manually, otherwise the previous mode will be operating.

◎INHIBIT

- When you need to check the real operating time, please use INHIBIT function.
- If you need to stop the time progressing, please use INHIBIT function.

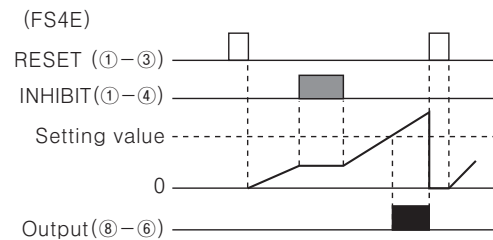

◎Environment

Please avoid the following places:

- Where this product may be damaged by strong impact or vibration.
- Where there are corrosive gas or flammable gas and water, oil, dust.
- Where magnetic and electrical noise occurs.
- Where there are High temperature and humidity beyond rated specification.
- Where there are strong alkalis and acids.
- Where there are direct rays of sun.

◎Noise

We test 2kV, Pulse width 1μs against Impulse voltage between power terminals and 1kV, pulse width 1μs at noise simulator against external noise voltage. Please install MP condenser (0.1~1μF) or Oil condenser between power terminals when over Impulse noise voltage occurs.

- When testing dielectric voltage and insulation resistance of the control panel with this unit installed.
 - ①Please isolate this unit from the circuit of control panel.
 - ②Please make all terminals of this unit short-circuited.

- Sudden function stop while it is running (When displaying wrong numbers or nothing) In this case, please power off and turn on again. This is due to strong noise flows into this product therefore please try to separate inductive load from input signal line of this product or install surge absorber between inductive loads.

(A) Counter

(B) Timer

(C) Temp. controller

(D) Power controller

(E) Panel meter

(F) Tacho/Speed/Pulse meter

(G) Display unit

(H) Sensor controller

(I) Proximity sensor

(J) Photo electric sensor

(K) Pressure sensor

(L) Rotary encoder

(M) 5-Phase stepping motor & Driver & Controller