

MT4Y/MT4W SERIES

Features

- Super version of panel meter
- Various output options (Basic specification: Indication type)
RS485 Communication output, Low speed serial output, BCD output, NPN/PNP open collector output, Relay output
- Max. measuring input specification :
500VDC, 500VAC, DC5A, AC5A
- Max. display range : -1999 ~ 9999
- High/Low scale function
- AC Frequency measuring function : 0.1~9999Hz
- Various functions :
Monitoring function for Max. and Min. display value,
Display cycle delay, Zero setting, high value correction,
Current output scale function
- Wide range of power voltage : 100-240VAC



! Please read "Caution for your safety" in operation manual before using.



Ordering information

MT 4 W - DV - 4 N

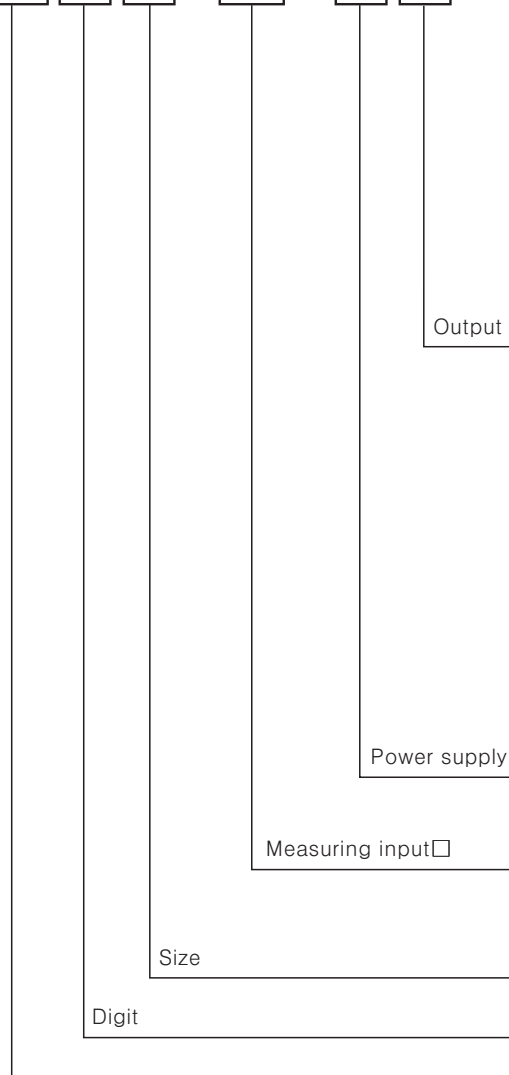

※ Blacked lines () are upgraded functions.

N	Indication type (No output function)
0	Relay contact output
1	NPN open collector output
2	PNP open collector output
3	Relay contact output + Current (4-20mADC) output
4	Relay contact output + RS485 communication output
5	BCD Dynamic output
6	Low speed serial output

※ Output (0-6) : Option

N	Indication type (No output function)
0	Relay contact output + Current (4-20mADC) output
1	Relay contact output
2	NPN open collector output + BCD Dynamic output
3	PNP open collector output + BCD Dynamic output
4	NPN open collector output + Current (4-20mADC) output
5	PNP open collector output + Current (4-20mADC) output
6	NPN open collector output + Low speed serial output
7	PNP open collector output + Low speed serial output
8	NPN open collector output + RS485 output
9	PNP open collector output + RS485 output

※ Output (0-9) : Option

4	100-240VAC
DV	DC Volt
DA	DC Ampere
AV	AC Volt
AA	AC Ampere
Y	DIN Size W72×H36mm
W	DIN Size W96×H48mm
4	4digit
MT	Multi Meter

※ When need to measure over 5ADC, please select DV type because shunt should be used.

※ **MT4Y Type is coming soon.**

MULTI PANEL METER

Specifications

Series	MT4Y-DV-□□ MT4Y-DA-□□	MT4Y-AV-□□ MT4Y-AA-□□	MT4W-DV-□□ MT4W-DA-□□	MT4W-AV-□□ MT4W-AA-□□
Measurement function	VDC, ADC	VAC, AAC, frequency	VDC, ADC	VAC, AAC, frequency
Power supply	100-240VAC 50/60Hz(90 ~ 110% of rated voltage)			
Power consumption	5VA			
Display method	7Segment LED Display (Red) (Character height:14.2mm)			
Display accuracy	(Note1) DC type: F · S ±0.1% Rdg ±2digit } 23℃ ±5℃ 35~85%Rh AC type: F · S ±0.3% Rdg ±3digit			
A/D conversion method	Over Sampling			
Sampling cycle	DC type:50ms, AC type:16.6ms (Resolution 1/12000)			
Max. display range	-1999 ~ 9999(4digit)			
Max. input	110% for each input specification(At 500VAC:120%)			
Main output	Relay output	• Contact capacity : 250VAC 3A, 30VDC 3A • Relay contact : N.O(1a)		
	NPN open collector output	12-24VDC ±2V 50mA Max. (Resistive load)		
	PNP open collector output			
Sub output (Transmission output)	RS485 communication output	• Transmission:1200/2400/4800/9600bps		• Transmission method:2wires half duplex
	Serial output	• Protocol:Modbus		• Synchronization method:Start-stop synchronization
	BCD output	NPN open collector output, 12-24VDC Max. 50mA (Resistive load)		
	4-20mA output	Resolution : 8000 division(Load resistance max. 600Ω)		
AC measuring method	Selectable RMS or AVG	_____	Selectable RMS or AVG	_____
Hold function	Built-in(Outer hold function)			
Insulation resistance	Min. 100MΩ (at 500VDC) between external terminal and case			
Dielectric strength	2000VAC for 1minute between external terminal and case			
Noise strength	±2kV the square wave noise(pulse width:1μs) by the noise simulator			
Vibration	Mechanical	0.75mm amplitude at frequency of 10 ~ 55Hz in each of X, Y, Z directions for 2hours		
	Malfunction	0.5mm amplitude at frequency of 10 ~ 55Hz in each of X, Y, Z directions for 10minutes		
Shock	Mechanical	100m/s ² (10G) in X, Y, Z directions for 3 times		
	Malfunction	300m/s ² (30G) in X, Y, Z directions for 3 times		
Relay life cycle	Malfunction	Min. 20,000,000 times		
	Mechanical	Min. 100,000 times(250VAC 3A Load current)		
Ambient temperature	-10 ~ +50℃ (at non-freezing status)			
Storage temperature	-20 ~ +60℃ (at non-freezing status)			
Ambient humidity	35 ~ 85%RH			
Approval	_____			CE
Weight	Approx. 134g		Approx. 211g	

※ **(Note1)** DC/AC type F · S ±0.5% Rdg ±3digit(at -10~+50℃). DC/AC type F · S ±1% Rdg ±3digit

Front panel identification

●MT4Y Series

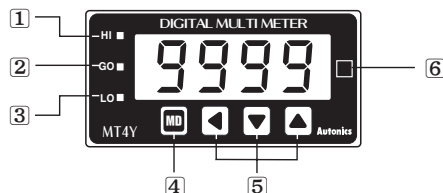

- ① HI : High output indication of preset
- ② GO : GO output indication of preset
- ③ LO : Low output indication of preset

●MT4W Series

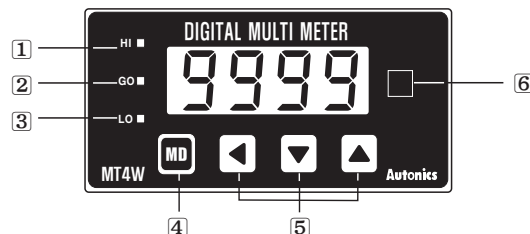

- ④ **[MD]** key : Enter to parameter group, Memorize the setting value, Move the parameter mode
- ⑤ **[Left]** key : Move the digit, Enter to parameter group
- [Down]**, **[Up]** key : Change the setting value.
- ⑥ Unit

※ There is no ①, ②, ③ on a display panel of MT4Y-□□-4N, 45, 46 and MT4W-□□-4N.

※ There is no ①, ② on a display panel of MT4Y-□□-43, 44, and GO output is changed to OUT.

(A) Counter

(B) Timer

(C) Temp. controller

(D) Power controller

(E) Panel meter

(F) Tacho/Speed/Pulse meter

(G) Display unit

(H) Sensor controller

(I) Proximity sensor

(J) Photo electric sensor

(K) Pressure sensor

(L) Rotary encoder

(M) 5-Phase stepping motor & Driver & Controller

MT4Y/MT4W SERIES

Connections

MT4Y series (Input terminal)

MT4Y-DV-□□

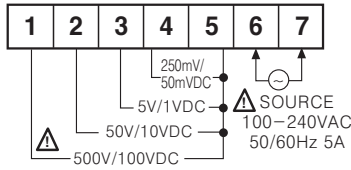

MT4Y-AV-□□

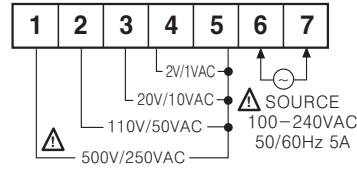

MT4Y-DA-□□

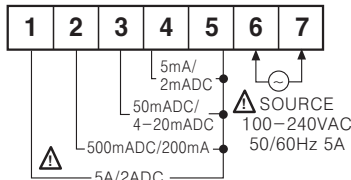

MT4Y-AA-□□

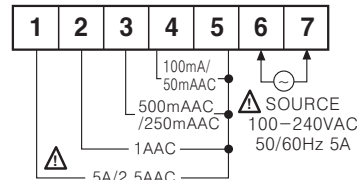

MT4Y Series (Output terminal)

MT4Y-□□-4N(Indicator)

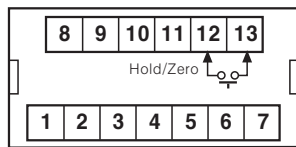

MT4Y-□□-40(Triple relay output)

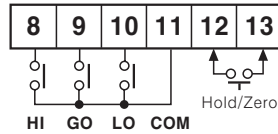

MT4Y-□□-41(Triple NPN O.C output)

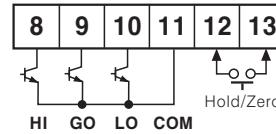

MT4Y-□□-42(Triple PNP O.C output)

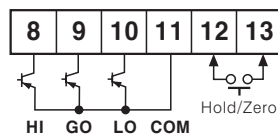

MT4Y-□□-43 (Relay output+current output)

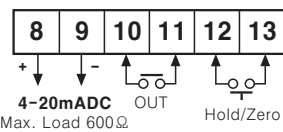

MT4Y-□□-44 (Relay output+RS485)

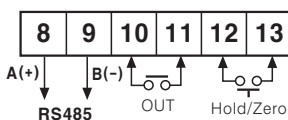

MT4Y-□□-45 (Low speed serial output)

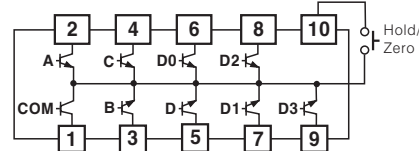

MT4Y-□□-46 (BCD output)

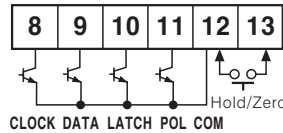

※ POL : When a display value is "-", it will be changed from High to Low.

※ Hirose connector:HIF3BD-10PA-2.54DS

MT4W Series (Input terminal)

MT4W-DV-□□

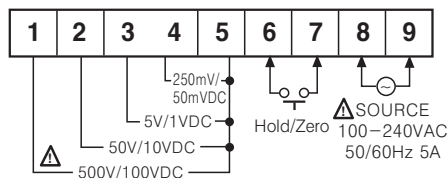

MT4W-AV-□□

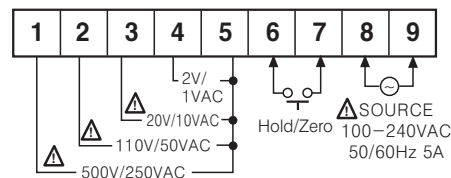

MT4W-DA-□□

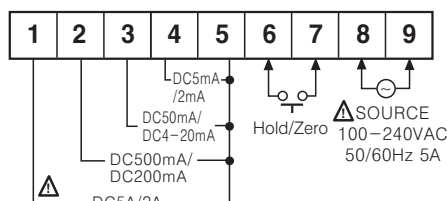

MT4W-AA-□□

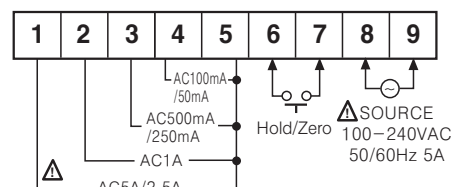

MULTI PANEL METER

○MT4W Series (Output terminal)

●MT4W-□□-40 (Triple relay output+Current output)

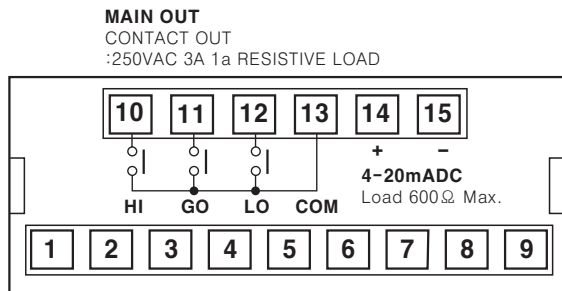

●MT4W-□□-41 (Triple relay output)

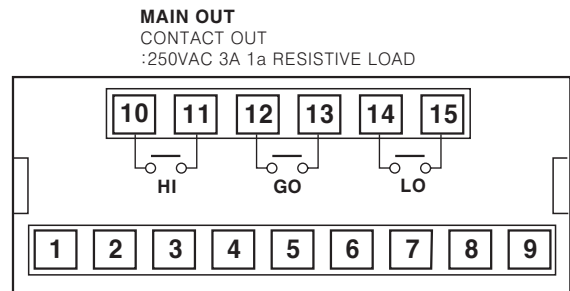

●MT4W-□□-42 / MT4W-□□-43 (Triple NPN/PNP open collector output+BCD output)

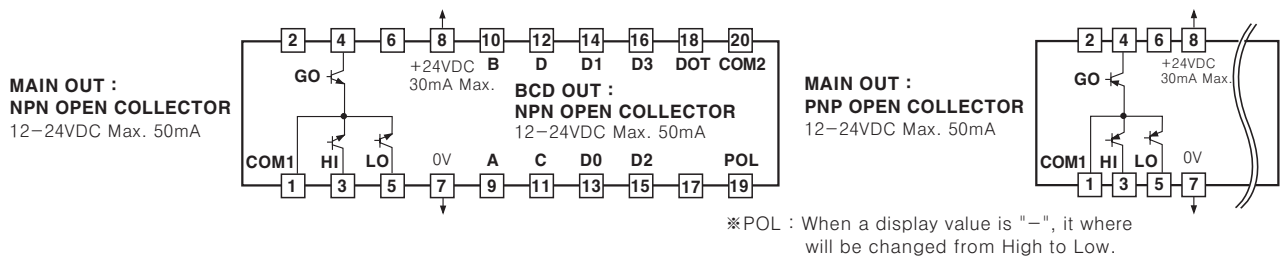

●MT4W-□□-44/ MT4W-□□-45 (Triple NPN/PNP open collector output+Current output)

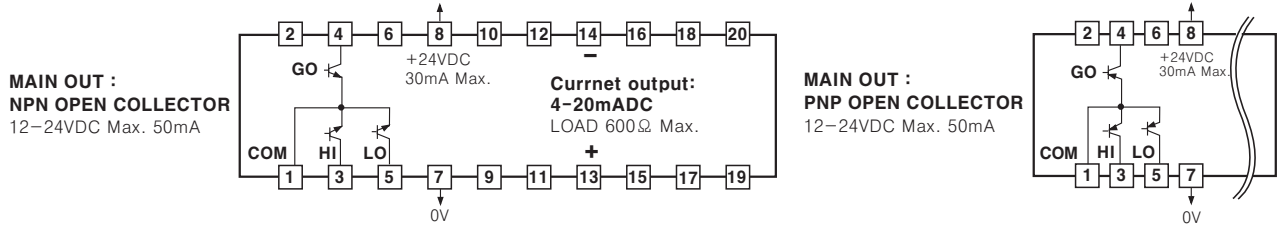

●MT4W-□□-46/ MT4W-□□-47 (Triple NPN/PNP open collector output+Low speed serial output)

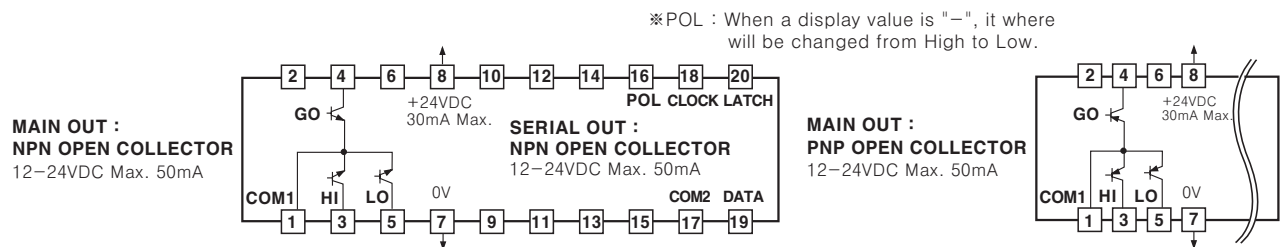

●MT4W-□□-48/ MT4W-□□-49 (Triple NPN/PNP open collector output+RS485 output)

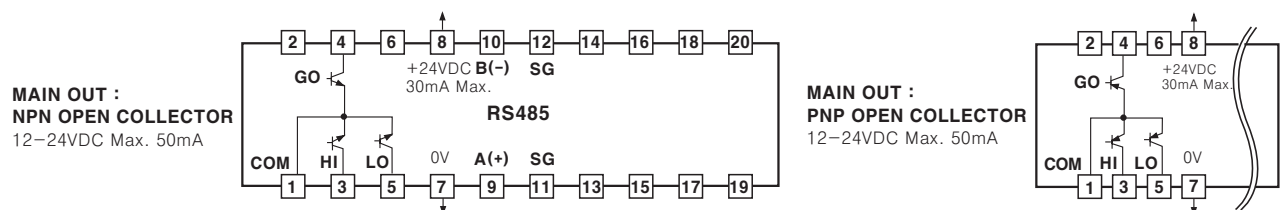

(A)
Counter

(B)
Timer

(C)
Temp.
controller

(D)
Power
controller

(E)
Panel
meter

(F)
Tacho/
Speed/
Pulse
meter

(G)
Display
unit

(H)
Sensor
controller

(I)
Proximity
sensor

(J)
Photo
electric
sensor

(K)
Pressure
sensor

(L)
Rotary
encoder

(M)
5-Phase
stepping
motor &
Driver &
Controller

MT4Y/MT4W SERIES

■ Dimensions

(Unit:mm)

- MT4Y-□□-4N, 45, 46

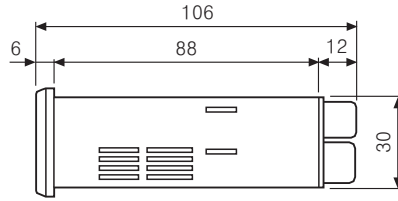
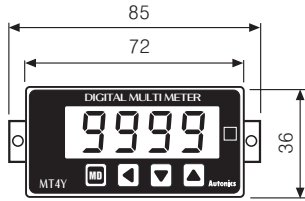

<MT4Y-□□-4N, 40~44, 46>

- Panel cut-out

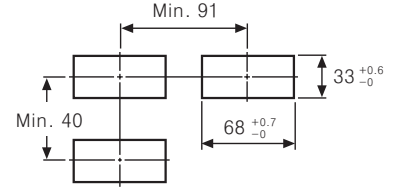

- MT4Y-□□-43, 44

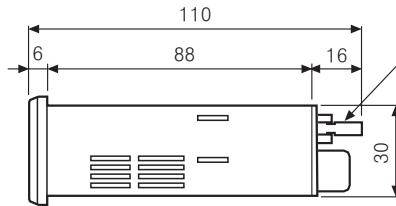

<MT4Y-□□-45>

10Pin Hirose connect
(HIF3BD-10PA-2.54DS)

- MT4Y-□□-40, 41, 42

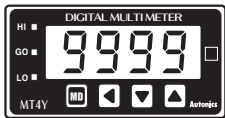

- MT4W-□□-4N (Indicator)

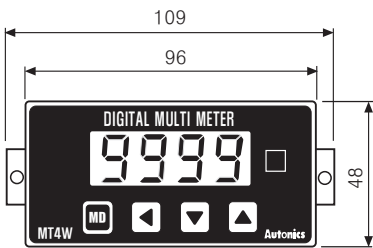

- MT4W-□□-4N, MT4W-□□-40, 41

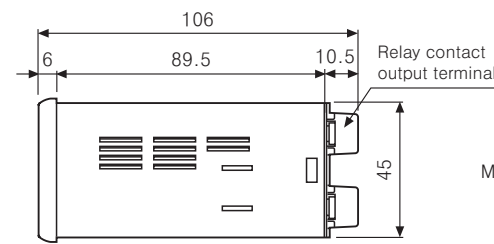

※ There is no Relay contact output terminal block in indication type.

- Panel cut-out

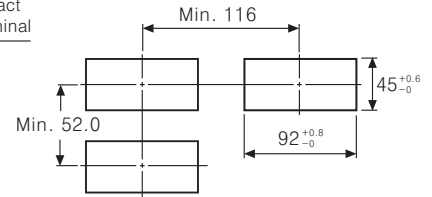

- MT4W-□□-40~49

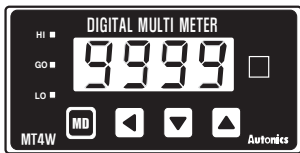

- MT4W-□□-42~49

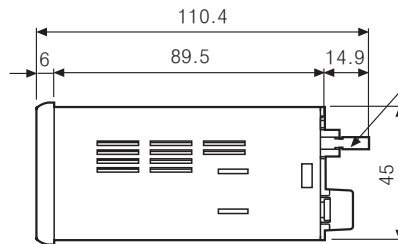

20pin Hirose Connet
(HIF3BA-20PA-2.54DS)

■ Parameter setting

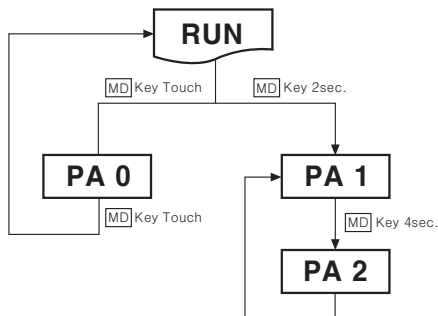

※ If pressing **MD** key, it enters into **PA-0** group.

But it is available neither when the monitoring time of **Pek.t** mode in **PA-2** group is set **00s** nor when **Out.t** mode is **oFF**.

※ When pressing **MD** key for 2 sec., **PA-1** is displayed.

※ When pressing **MD** key for 4 sec., **PA-2** is displayed after **PA-1**.

※ When **PA-1** or **PA-2** is displayed and releasing **MD** key, it enters into the parameter.

※ After entering into a parameter, if pressing **MD** key for 3 sec., it returns to **RUN** mode automatically.

MULTI PANEL METER

PARAMETER 1 group

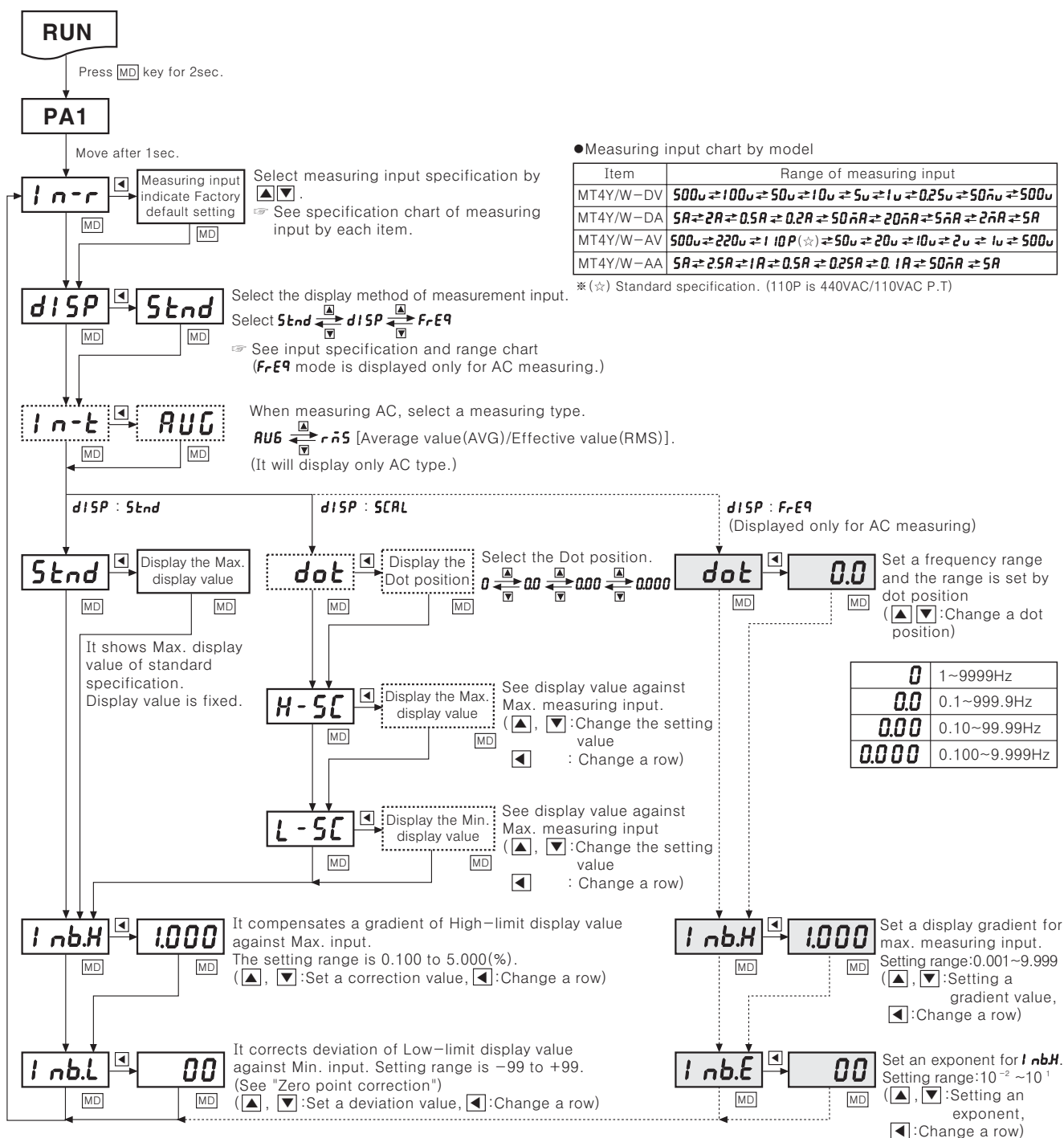

(A) Counter

(B) Timer

(C) Temp. controller

(D) Power controller

(E) Panel meter

(F) Tacho/Speed/Pulse meter

(G) Display unit

(H) Sensor controller

(I) Proximity sensor

(J) Photo electric sensor

(K) Pressure sensor

(L) Rotary encoder

(M) 5-Phase stepping motor & Driver & Controller

Factory default setting

Mode	MT4Y/W-DV	MT4Y/W-DA	MT4Y/W-AV	MT4Y/W-AA	Mode	MT4Y/W-DV	MT4Y/W-DA	MT4Y/W-AV	MT4Y/W-AA
In-r	500V	5A	500V	5A	Inb.H	1.000	1.000	1.000	1.000
dISP	Stnd	Stnd	Stnd	Stnd	Inb.L	00	00	00	00
In-t	—	—	AUG	AUG	dot	—	—	00	00
Stnd	500.0	5.000	500.0	5.000	Inb.E	—	—	10 0	10 0

MT4Y/MT4W SERIES

PARAMETER 2 group

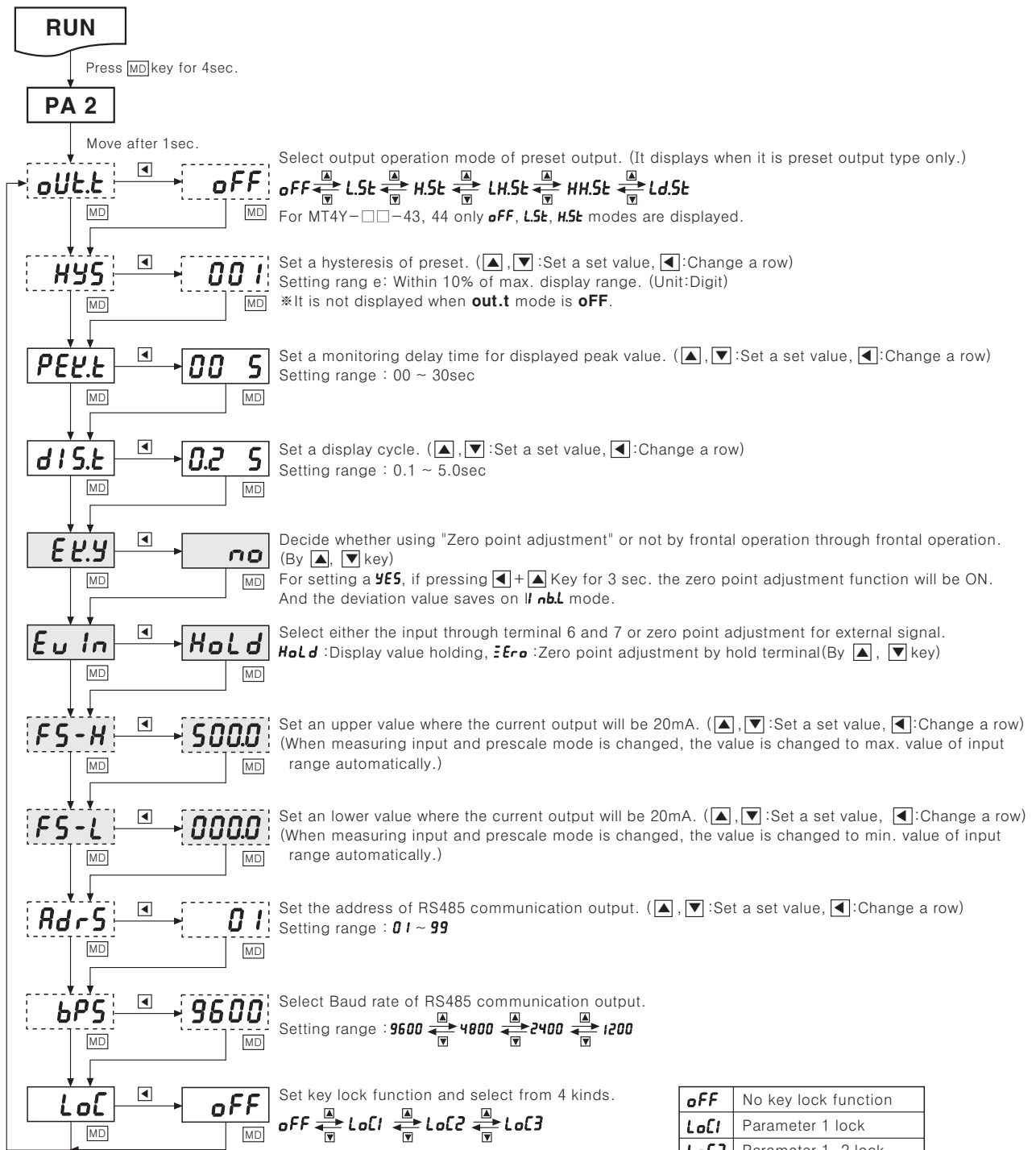

- ※ Blacked boxes (■) are new modes.
- ※ The modes noted on dotted boxes are available only for option output type.
- ※ After setting each mode, press **[MD]** Key for 2 sec. to return to **RUN** mode.
- ※ If no key touched for 60sec. after enter into PARAMETER, it will return to **RUN** mode.

Factory default setting

Mode	MT4Y/W-DV	MT4Y/W-DA	MT4Y/W-AV	MT4Y/W-AA	Mode	MT4Y/W-DV	MT4Y/W-DA	MT4Y/W-AV	MT4Y/W-AA
out.t	oFF	oFF	oFF	oFF	FS-H	500.0	500.0	500.0	500.0
HYS	00 1	00 1	00 1	00 1	FS-L	000.0	000.0	000.0	000.0
PEEL.t	00 5	00 5	00 5	00 5	AdRS	0 1	0 1	0 1	0 1
DIS.t	0.2 5	0.2 5	0.2 5	0.2 5	bPS	9600	9600	9600	9600
ELY	no	no	no	no	LoC	oFF	oFF	oFF	oFF
EuIn	HoLd	HoLd	HoLd	HoLd					

MULTI PANEL METER

PARAMETER 0 group

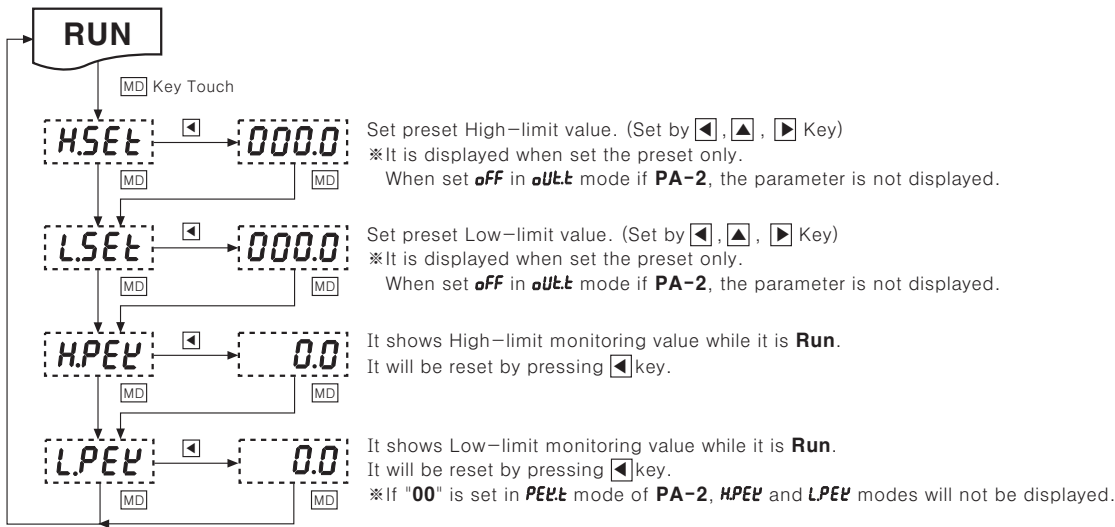

*If no key touched for 60 sec. after enter into parameter, it will return to **Run**.

Factory default setting

Mode	MT4Y/W-DV	MT4Y/W-DA	MT4Y/W-AV	MT4Y/W-AA	Mode	MT4Y/W-DV	MT4Y/W-DA	MT4Y/W-AV	MT4Y/W-AA
HSEt	000.0	000.0	000.0	000.0	HPEt	0.0	0.000	0.0	0.000
LSEt	000.0	000.0	000.0	000.0	LPEt	0.0	0.000	0.0	0.000

Specification and range

*Blacked boxes (■) are new modes.

Type	Measuring input and range	Input impedance	Standard [Stnd]	Prescale [SCAL]
			Display range [Fixed]	Display range [Variable]
DC Volt	0-500V [500V]	4.33M Ω	0.0~500.0	(Display point will be different according to decimal point position.)
	0-100V [100V]	4.33M Ω	0.0~100.0	
	0-50V [50V]	433.15k Ω	0~50.00	
	0-10V [10V]	433.15k Ω	0.000~10.00	
	0-5V [5V]	43.15k Ω	0.000~5.000	
	0-1V [1V]	43.15k Ω	0.000~1.000	
	0-250mV [0.25V]	2.15k Ω	0.0~250.0	
DC Ampere	0-50mV [50mV]	2.15k Ω	0.00~50.00	
	0-5A [5A]	0.01 Ω	0.000~5.000	
	0-2A [2A]	0.01 Ω	0.000~2.000	
	0-500mA [0.5A]	0.1 Ω	0.0~500.0	
	0-200mA [0.2A]	0.1 Ω	0.0~200.0	
	0-50mA [0.05A]	1.0 Ω	0.00~50.00	
	4-20mA [20mA]	1.0 Ω	0.00~20.00	
AC Volt	0-5mA [5mA]	10.0 Ω	0.000~5.000	
	0-2mA [2mA]	10.0 Ω	0.000~2.000	
	0-500V [500V]	4.98M Ω	0.0~500.0	
	0-250V [250V]	4.98M Ω	0.0~250.0	
	0-110V [110V]	1.08M Ω	0.0~440.0	
	0-50V [50V]	1.08M Ω	0.00~50.00	
	0-20V [20V]	200k Ω	0.00~20.00	
AC Ampere	0-10V [10V]	200k Ω	0.00~10.00	
	0-2V [2V]	20k Ω	0.000~2.000	
	0-1V [1V]	20k Ω	0.000~1.000	
	0-5A [5A]	0.01 Ω	0.000~5.000	
	0-2.5A [2.5A]	0.01 Ω	0.000~2.500	
	0-1A [1A]	0.05 Ω	0.000~1.000	
	0-500mA [0.5A]	0.1 Ω	0.0~500.0	
AC Ampere	0-250mA [0.25A]	0.1 Ω	0.0~250.0	
	0-100mA [0.1A]	0.5 Ω	0.0~100.0	
	0-50mA [50mA]	0.5 Ω	0.00~50.00	

(A) Counter

(B) Timer

(C) Temp. controller

(D) Power controller

(E) Panel meter

(F) Tacho/Speed/Pulse meter

(G) Display unit

(H) Sensor controller

(I) Proximity sensor

(J) Photo electric sensor

(K) Pressure sensor

(L) Rotary encoder

(M) 5-Phase stepping motor & Driver & Controller

MT4Y/MT4W SERIES

■ Functions

◎ Measuring AC frequency (PA1 : dISP mode of FrEq)

Measure the frequency of input signal for AC input. Measuring range is 0.1 to 3000Hz, and it is changed by dot position as below table.

Dot position	0.000	0.00	0.0	0
Measuring range	0.100~9.999Hz	0.10~99.99Hz	0.1~999.9Hz	1~9999Hz

It is available to correct a gradient of high-limit display value on **PA 1**. However, to measure a frequency normally, over than $F \cdot S$ 10% of input signal need to be supplied. Otherwise it will not be able to measure a frequency normally.

◎ Zero point correction (Deviation correcting for low-limit display value)

When supplying min. input on an input terminal, zero is set as a current display value.

There are 3 ways for correcting an error as below. Moreover, when the correcting is normally done by front key or external hold/zero terminal, a deviation value will be saved on **lnbL** mode of **PA 1**.

Corrections	Correction value input	Frontal key	External input signal
Description	Input a deviation value directly on lnbL of PA 1 .	Supply a min. input on an input terminal and then press [] + [] key for 3 sec.	Short the external hold/zero terminal, # 6 and #7, for more than 50ms.

※See the "Error correction" for correcting low display value.

◎ Current output (DC4~20mA) Scale correction function (PA2 : FS-H / FS-L mode)

4~20mA DC is outputted within set range in **FS-H** and **FS-L** mode to transmit a current display value to another one. For higher value on **FS-H** mode, the output is 20mA. For lower value on **FS-L** mode, the output is 4mA. (Resolution 8000, the lower $F \cdot S$ range, the lesser resolution)

※The minimum interval between **FS-H** and **FS-L** is 10% $F \cdot S$. And 10% of set value is fixed for the lower value.

※The output is 4mA when current display value is lower than **FS-L**, and the output is 20mA when current value is higher than **FS-H**.

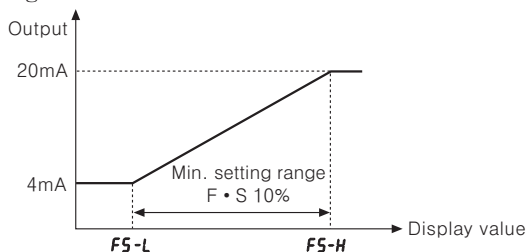

◎ Reset (Factory default)

It makes every set statue to factory default. When pressing **[]** **[]** **[]** key for 2 sec., **lnbL** mode and set value (**no**) are displayed every 0.5 sec.. And if pressing **[MD]** key after changing set value from **no** to **YES**, the current value of each parameter will change to factory default statue.

◎ Error display

Display	Note
HHHH	Flickering when measuring input exceeds the max. input (110%)
LLLL	Flickering when measuring input exceeds the min. input (-10%)
d-HH	Flickering when a display value exceeds H-SC value.
d-LL	Flickering when a display value exceeds L-SC value.
F-HH	Flickering when an input frequency exceeds Max. set value.
ovEr	Flickering for over the range of zero point adjustment (± 99).

※The Error will be removed for the values within measuring range or display range.

※"LLLL" signal is displayed only for 4~20mA input.

※When exceeding zero point range, it returns to operation mode after "ovEr" signal is displayed.

◎ Prescale function (PA 1 : H-SC/L-SC mode)

This function is to display setting (-1999 to 9999) of particular High/Low-limit value in order to display High/Low-limit value of measuring input. If measuring inputs are a or b and particular values are A or B, it will display $a=A$, $b=B$ as below graph.

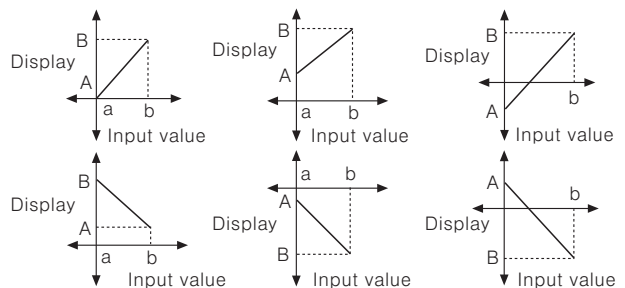

◎ Gradient correction function (PA1: nbnH mode)

This function is to correct a gradient of prescale value and display value. (Fig.1) Display value Y can be used as α , β times against X input value by correction function [**lnbnH**]. And also can be used as correction function of max. display value (**H-SC**). Adjustment range is 0.100 to 5.000 and multiply current gradient.

Ex) Input: 200mVDC, Display: 3.000 for MT4W-DV

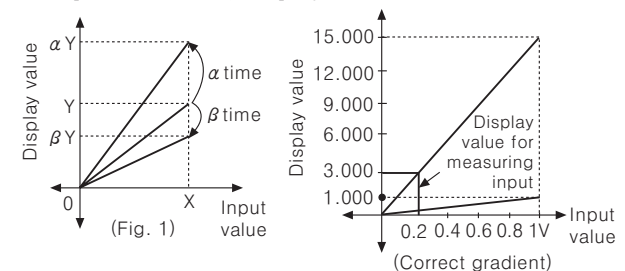

- ① Select 0~1VDC for measuring input in Parameter1.
- ② Standard specification in input : 0 to 1VDC and 1.000 therefore it has to be 15.000 (**H-SC**) for 1VDC (input) in order to display 3.000 for 200mVDC (input). But it is unable due to setting range is 9.999
- ③ In this case, please check below chart.

Please set as **lnbnH** × **H-SC** = 15.000

Setting	H-SC	L-SC	lnbnH	Other
①	Disable	0.000	1.000	It will be the same display value.
②	7.500	0.000	2.000	
③	5.000	0.000	3.000	
④	3.750	0.000	4.000	
⑤	3.000	0.000	5.000	

MULTI PANEL METER

Correction function (PA 1: *l nb.H* / *l nb.L* mode)

This function is for correcting display value error of measuring input.

l nb.H : 0.100 ~ 5.000 [Correct gradient(%) of High value]

l nb.L : -99 ~ +99 [Adjust deviation of Low value]

Ex) When measuring input range is 0~500VDC and a display value is 0.0~500.0.

How to correct a High display value

For 500V of measuring input, if a high display value is "500.5", the correcting value for an offset is $5000 \div 5005 = 0.999$. By setting 0.999 on *l nb.H*, correcting a deviation of high display value is available.

A dot point is not calculated.

How to correct a Low display value

For 0V of measuring input and "001.2" of low display value, when setting -12 on *l nb.L*, the offset will be removed. A dot point is not calculated

Display cycle delay function(PA 2:*d i S.t* mode)

It is difficult to read as display value follows the measuring input value. Display when the measuring input value is fluctuating. In this case it is able to make display value stable by delaying display cycle. Display cycle displaying time can be changed in *d i S.t* mode of Parameter 2 (Setting range: 0.1~5.0sec). If select *S D S*, the display value is displayed every 5sec. averaging input value for 4sec.

Monitoring function for Peak display value (PA 0: *H.PE.L*/*L.PE.L* mode)

It is to observe Max./Min. value of display value by current display value and then display the data in *H.PE.L* mode and *L.PE.L* mode of parameter 0.

Set delay time (0~30sec.) in *PE.L.t* mode of parameter 2 in order to prevent malfunction caused by initial over current or over voltage, when it monitor the peak value. Delay time is 0~30sec. and it will monitor the peak value after setting time. If press \blacktriangleleft key at *H.PE.L* and *L.PE.L* mode of parameter 0, monitoring data will be initialized.

Preset output Mode[PA 2 : *o U.t.t* mode]

Mode	Output operation	Operation
		H: Hysteresis
<i>oFF</i>		No output
<i>LSt</i>		If it is equal or smaller than Low setting value, LO output will be ON. If it is bigger than Low setting value, GO output will be ON.
<i>HSt</i>		If it is equal or bigger than High setting value, HI output will be ON. If it is equal or smaller than High setting value, GO output will be ON.
<i>LHSt</i>		If it is equal or smaller than Low setting value and equal or bigger than High setting value, the output will be ON. If it is bigger than Low setting value and smaller than High setting value, GO output will be ON.
<i>HHSt</i>		If it is equal or bigger than Low set and equal or bigger than High set value, output will be ON. If it is smaller than Low setting value and High setting value, GO output will be ON.
<i>LLSt</i>		If it is equal or smaller than Low setting value and equal or bigger than high setting value, the output will be ON. If it is bigger than low and high setting value, Go output will be ON.
<i>LdSt</i>		This operation is the same as L.St. But it doesn't operate at initial Low set value, it will operate at next Low set value. If this is higher than Low set value, Go output will be ON.

*"H" means hysteresis and able to set 1 to 99 at "HYS" mode in parameter 2 among above comparison output chart.

*MT4Y-□□-43, 44 can use *LSt*, *HSt*, *LdSt* mode.

Retransmission function(Sub output)

RS485 communication output(32 channels)

It is able to set address(01~99)

It is able to transmit by selecting modulation speed (Transmitted number of signal per 1sec.) of serial transmission. (Selectable 1200, 2400, 4800, 9600bps)

Low-speed serial output

It outputs current display value as Low-frequency (50Hz) type.

Current output(4~20mADC)

It outputs 4~20mADC against High/Low-limit scale. (Resolution:8,000 division)

BCD output

It outputs display value as BCD Code.

***Only one sub-output is selectable(More than one sub-output is not allowed.)**

Time chart of Low speed serial output and BCD output

BCD output(Negative logic)

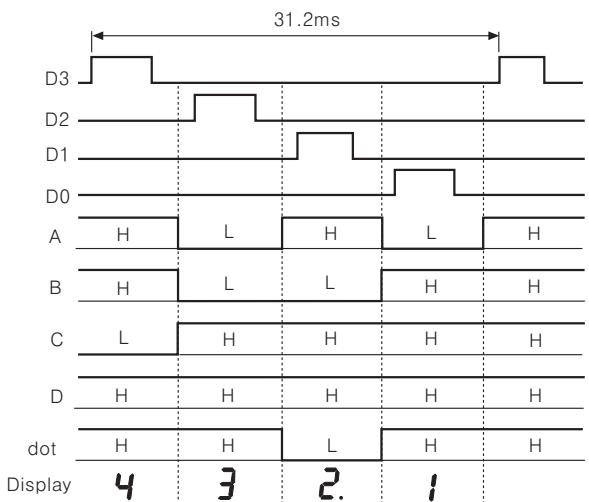
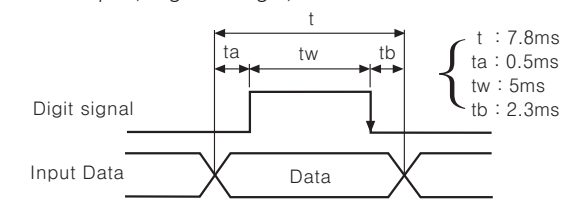

Low speed serial output(Negative logic)

-Clock frequency:50Hz

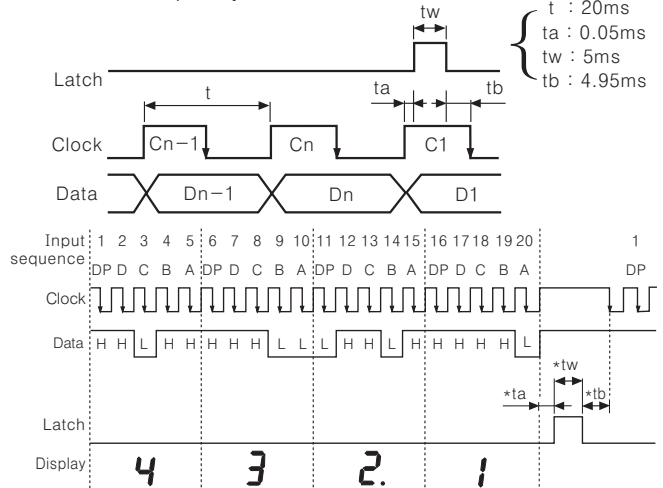

*When clock pulse changed from High to Low, Data will be read.

(A) Counter

(B) Timer

(C) Temp. controller

(D) Power controller

(E) Panel meter

(F) Tacho/Speed/Pulse meter

(G) Display unit

(H) Sensor controller

(I) Proximity sensor

(J) Photo electric sensor

(K) Pressure sensor

(L) Rotary encoder

(M) 5-Phase stepping motor & Driver & Controller

MT4Y/MT4W SERIES

Communication output

Interface

Standard	EIA RS485
Maximum connections	32(Address setting:01~99)
Communication method	2-wire half duplex
Communication type	Asynchronous
Effective communication distance	Max. 800m
Communication speed	1200, 2400, 4800, 9600bps
Start bit	1 (Fixed)
Stop bit	1 (Fixed)
Parity bit	none
Data bit	8bit(Fixed)
Protocol	MODBUS RTU

Application of system ordering

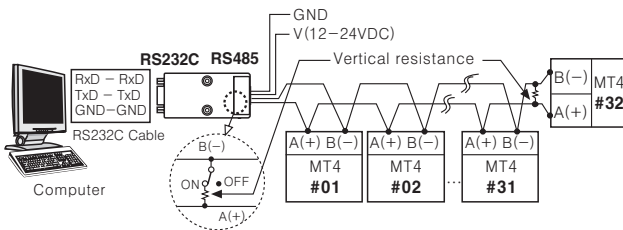

※SCM-38I made by Autonics should be used for RS232C to RS485 converter.

※Proper twist pair cable needed for communication cable.

Communication control ordering

1. The communication control ordering of MT4Y/W series is protocol(Not compatible with other system).
2. After 0.5sec. being supplied the power in to upper system, then able to start communicating.
3. Initial communication will be started by upper system. When Query signal come out from upper system then MT4Y/W series will response.

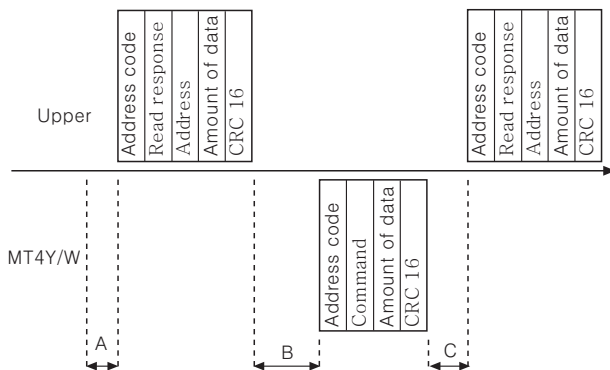

※A → Over min. 0.5sec

B →
 9600bps : Within 10.4ms
 4800bps : Within 20.8ms
 2400bps : Within 41.6ms
 1200bps : Within 83.3ms

C →
 9600bps : Within 4.2ms
 4800bps : Within 8.4ms
 2400bps : Within 16.7ms
 1200bps : Within 33.4ms

Communication command and block

The format of query and response

Query

Unit number	Command	Start code	Amount of data	CRC16
①	②	③	④	⑤
Calculation range of CRC16 Check Sum				

①Unit number

This code is upper system can discern MT4Y/W series and able to set within range of 01 to 99.

②Command:Read command for input register

③Start code:It is the start address of input register.

It can be set from 0000 to 0003.

④Amount of data:The number of 16 bit data on start code. (No. of Points)

⑤CRC16:

CRC16 is for more reliable transmit/receive to check the error between transmitter and receiver.

Response

Unit number	Response Command	Amount of data	Measured value	Dot position	High Peak	Low Peak	CRC16
①	②	③	④	⑤	⑥	⑦	⑧
Calculation range of CRC16 Check Sum							

①Unit number:Distinguish MT4Y/W and the number is available from 01 to 99.

②Response command:

A response for read command of input register (See Modbus Mapping Table)

③Amount of data:The number of 16 bit data on start code. (No. of Points)

④Measured value:Measure 16bit data with MT4Y/W. The measured valued does not include the data for dot point.

⑤Dot position:Dot position displayed on Parameter 1 dot mode.

⑥High Peak:Maximum measured value.

⑦Low Peak:Minimum measured value.

⑧CRC16:Checking a whole block.

Application for communication command

Ex) When a display value is 220.3V, dot point is 0.0, high peak value is 220.4, and low peak is 0000

Query

Unit number	Command	Start code		Amount of data		CRC16	
		High	Low	High	Low	High	Low
00	04	00	00	00	04	CRC16	

Response

Unit number	Response command	Amount of data		Measured value		dot position		Hi Peak		Lo Peak		CRC16
		High	Low	High	Low	High	Low	High	Low	High	Low	
01	04	00	08	08	9B	00	01	08	9C	00	00	CRC16

MULTI PANEL METER

- (A) Counter
- (B) Timer
- (C) Temp. controller
- (D) Power controller
- (E) Panel meter
- (F) Tacho/Speed/Pulse meter
- (G) Display unit
- (H) Sensor controller
- (I) Proximity sensor
- (J) Photo electric sensor
- (K) Pressure sensor
- (L) Rotary encoder
- (M) 5-Phase stepping motor & Driver & Controller

●Error handling (Slave → Master)

1. Non support command

Unit number	Response command	Exception code	CRC16	
01	81	01	81	90

※Set a received highest bit and send it to response command and exception code 01.

2. A start code of queried data is inconsistent with the transmittable code.

Unit number	Response command	Exception code	CRC16	
01	81	02	81	90

※Set a received highest bit and send it to response command and exception code 02.

3. Amount of queried data is inconsistent with a transmittable one.

Unit number	Response command	Exception code	CRC16	
01	81	02	—	—

※Set a received highest bit and send it to response command and exception code 04.

◎Modbus Mapping Table

●Read Holding Register

Start code	Com-mand	Transmission	Note
30001 (0000)	04	Measured value • Standard: Able to transmit from -5% to 100% of display range • Scale: Able to transmit from -1999 to 9999% of display range	Data transmission for error • Standard: "HHHH" → "9999" "LLLL" → "-1999" • Scale: Transmit a set value of H-SC and L-SC "d-HH" → "9999" "d-LL" → "-1999"
30002 (0001)	04	Dot set value	Transmit a set value for dot point on PA-1 dot mode. • Standard: 0.000→0003H, 0.00→0002H, 0.0→0001H, 0→0000H, • Scale: 0.000→0103H, 0.00→0102H, 0.0→0101H, 0→0100H,
30003 (0002)	04	High Peak value	Transmit a maximum measured value
30004 (0003)	04	Low Peak value	Transmit a minimum measured value

●Read Coil Status

Start code	Com-mand	Transmission	Note
10001 (0000)	02	Output operation • 0001h: Lo output • 0002h: Go output • 0003h: Hi output	Transmit "1" for ON and "0" for OFF

◎Setting a communication speed

Set a communication speed on **PA 2 bps** mode. Factory default is **9600**bps.

◎Setting a communication unit number (Setting range: 01~99)

Set a communication speed on **PA 2 ADRS** mode. Factory default is **01**. Even though the unit number can be set maximum 99, the connectable MT4Y/W to higher system is up to 32.

◎CRC16 Table

●High Byte Table

	0	1	2	3	4	5	6	7	8	9	A	B	C	D	E	F
0	0x00	0xC1	0x81	0x40	0x01	0xC0	0x80	0x41	0x01	0xC0	0x80	0x41	0x00	0xC1	0x81	0x40
1	0x01	0xC0	0x80	0x41	0x00	0xC1	0x81	0x40	0x00	0xC1	0x81	0x40	0x01	0xC0	0x80	0x41
2	0x01	0xC0	0x80	0x41	0x00	0xC1	0x81	0x40	0x00	0xC1	0x81	0x40	0x01	0xC0	0x80	0x41
3	0x00	0xC1	0x81	0x40	0x01	0xC0	0x80	0x41	0x01	0xC0	0x80	0x41	0x00	0xC1	0x81	0x40
4	0x01	0xC0	0x80	0x41	0x00	0xC1	0x81	0x40	0x00	0xC1	0x81	0x40	0x01	0xC0	0x80	0x41
5	0x00	0xC1	0x81	0x40	0x01	0xC0	0x80	0x41	0x01	0xC0	0x80	0x41	0x00	0xC1	0x81	0x40
6	0x00	0xC1	0x81	0x40	0x01	0xC0	0x80	0x41	0x01	0xC0	0x80	0x41	0x00	0xC1	0x81	0x40
7	0x01	0xC0	0x80	0x41	0x00	0xC1	0x81	0x40	0x00	0xC1	0x81	0x40	0x01	0xC0	0x80	0x41
8	0x01	0xC0	0x80	0x41	0x00	0xC1	0x81	0x40	0x00	0xC1	0x81	0x40	0x01	0xC0	0x80	0x41
9	0x00	0xC1	0x81	0x40	0x01	0xC0	0x80	0x41	0x01	0xC0	0x80	0x41	0x00	0xC1	0x81	0x40
A	0x00	0xC1	0x81	0x40	0x01	0xC0	0x80	0x41	0x01	0xC0	0x80	0x41	0x00	0xC1	0x81	0x40
B	0x01	0xC0	0x80	0x41	0x00	0xC1	0x81	0x40	0x00	0xC1	0x81	0x40	0x01	0xC0	0x80	0x41
C	0x00	0xC1	0x81	0x40	0x01	0xC0	0x80	0x41	0x01	0xC0	0x80	0x41	0x00	0xC1	0x81	0x40
D	0x01	0xC0	0x80	0x41	0x00	0xC1	0x81	0x40	0x00	0xC1	0x81	0x40	0x01	0xC0	0x80	0x41
E	0x01	0xC0	0x80	0x41	0x00	0xC1	0x81	0x40	0x00	0xC1	0x81	0x40	0x01	0xC0	0x80	0x41
F	0x00	0xC1	0x81	0x40	0x01	0xC0	0x80	0x41	0x01	0xC0	0x80	0x41	0x00	0xC1	0x81	0x40

●Low Byte Table

	0	1	2	3	4	5	6	7	8	9	A	B	C	D	E	F
0	0x00	0xC0	0xC1	0x01	0xC3	0x03	0x02	0xC2	0xC6	0x06	0x07	0xC7	0x05	0xC5	0xC4	0x04
1	0xC0	0x0C	0x0D	0xC0	0x0F	0xCF	0xCE	0x0E	0x0A	0xCA	0xCB	0x0B	0xC9	0x09	0x08	0xC8
2	0xD8	0x18	0x19	0xD9	0x1B	0xDB	0xDA	0x1A	0x1E	0xDE	0xDF	0x1F	0xDD	0x1D	0x1C	0xDC
3	0x14	0xD4	0xD5	0x15	0xD7	0x17	0x16	0xD6	0xD2	0x12	0x13	0xD3	0x11	0xD1	0xD0	0x10
4	0xF0	0x30	0x31	0xF1	0x33	0xF3	0xF2	0x32	0x36	0xF6	0xF7	0x37	0xF5	0x35	0x34	0xF4
5	0x3C	0xFC	0xFD	0x3D	0xFF	0x3F	0x3E	0xFE	0xFA	0x3A	0x3B	0xFB	0x39	0xFB	0xFA	0x3A
6	0x28	0xE8	0xE9	0x29	0xEB	0x2B	0x2A	0xEA	0xEE	0x2E	0x2F	0xEF	0x2D	0xED	0x2C	0xE0
7	0xE4	0x24	0x25	0xE5	0x27	0xE7	0xE6	0x26	0x22	0xE2	0xE3	0x23	0xE1	0x21	0x20	0xE0
8	0xA0	0x60	0x61	0xA1	0x63	0xA3	0xA2	0x62	0x66	0xA6	0xA7	0x67	0xA5	0x65	0x64	0xA4
9	0x6C	0xAC	0xAD	0x6D	0xAF	0x6F	0x6E	0xAE	0xAA	0x6A	0x6B	0xAB	0x69	0xA9	0xA8	0x68
A	0x78	0xB8	0xB9	0x79	0xBB	0x7B	0x7A	0xBA	0xBE	0x7E	0x7F	0xBF	0x7D	0xBD	0xBC	0x7C
B	0xB4	0x74	0x75	0xB5	0x77	0xB7	0xB6	0x76	0x72	0xB2	0xB3	0x73	0xB1	0x71	0x70	0xB0
C	0x50	0x90	0x91	0x51	0x93	0x53	0x52	0x92	0x96	0x56	0x57	0x97	0x55	0x95	0x94	0x54
D	0x9C	0x5C	0x5D	0x9D	0x5F	0x9F	0x9E	0x5E	0x5A	0x9A	0x9B	0x5B	0x99	0x59	0x58	0x98
E	0x88	0x48	0x49	0x89	0x4B	0x8B	0x8A	0x4A	0x4E	0x8E	0x8F	0x4F	0x8D	0x4D	0x4C	0x8C
F	0x44	0x84	0x85	0x45	0x87	0x47	0x46	0x86	0x82	0x42	0x43	0x83	0x41	0x81	0x80	0x40

■Caution for using

1. It is not possible to modify Parameter(Baud rate, Address etc)related to communication of MT4Y/W series on line with upper systems such as PC, PLC etc. (Error will occur)
2. First make communication Parameter of MT4Y/W series and upper system one.
3. It is not allow to set overlapping communication number at the same communication line. (Error will occur)
4. Please use Twist pair wire for RS485 communication.
5. The total length of communication is 800m and over 32 equipment can be connected.
6. When connect communication cable between MT4Y/W series and upper systems, the vertical resistance(100 to 200Ω) must be installed at between both communication lines.